

OPERATION MANUAL
MICROWAVE SYSTEM ANALYZER
ME453K/L/M
ME538K/L/M

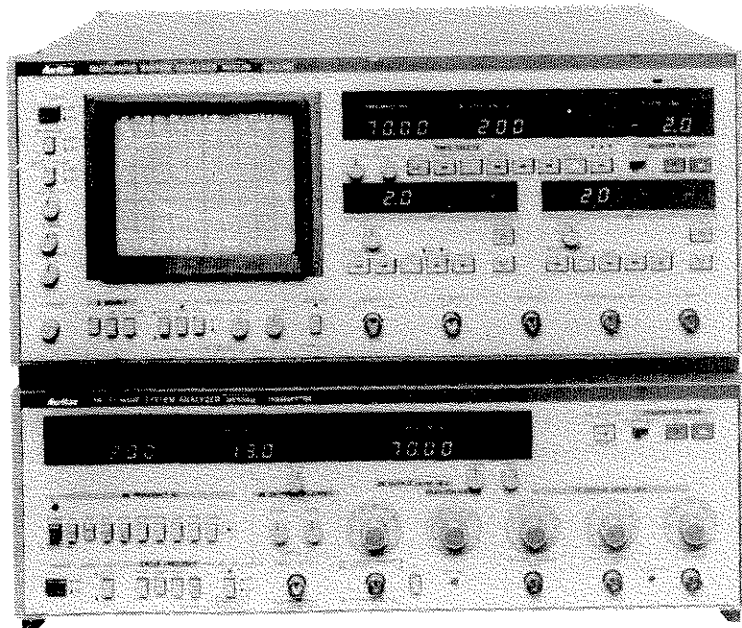



• Dual Trace Display Included IF Return Loss characteristic	15
• Changing the 20 dB calibration factor	15
• CRT sensitivity 5 dB/div	16
• Simultaneous measurement of IF return loss and BB delay (or BB linearity)	16
BB RETURN LOSS	17
BB TO BB AMPLITUDE RESPONSE (Swept method)	18
DC CHARACTERISTIC	19
AM-PM CONVERSION COEFFICIENT	20
For items other than the above, see 3, MEASUREMENTS GUIDE.	
7. Special measurements	
MEASUREMENT FOR COMMUNICATIONS SATELLITES	21
LOW BB FREQUENCY (55.6 kHz or 27.8 kHz) MEASUREMENT	21
REMOTE MONITORING	22
8. Appendix	
SPECIFICATIONS	23
CHART OF GROUP-DELAY MEASURING ERROR DUE TO AM-PM CONVERSION	24
TABLE OF CONVERSION OF GROUP DELAY AND DIFFERENTIAL PHASE	25

Note: For GP-IB refer to the separate GP-IB manual.

APPLICATIONS

Application

The Microwave System Analyzer measures the characteristics of the IF and baseband of terrestrial radio relay links or satellite links.

The Microwave System Analyzer can be used to measure FDM-FM links and the new digital microwave communication links.

The Microwave System Analyzer is useful in link device adjustment, construction, maintenance, research and development applications.

Composition

The Microwave System Analyzer includes two panels as shown below and accessories.

Characteristics Measured

- (1) Group delay characteristics
- (2) Linearity of modulator and demodulator
- (3) Differential phase characteristics
- (4) Differential gain characteristics
- (5) IF amplitude characteristics
- (6) BB amplitude characteristics (option)
- (7) IF return loss } Optional return loss
- (8) BB return loss } bridges are necessary.
- (9) Sensitivity of modulator and demodulator
- (10) Frequency deviation
- (11) AM to PM conversion coefficient
- (12) DC characteristic
- (13) IF counter
- (14) Power, gain and loss

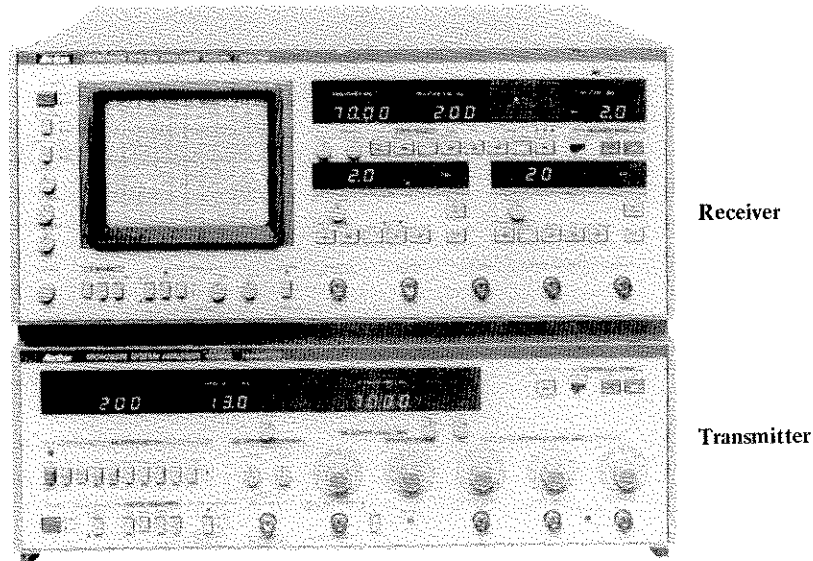

Front view

ACCESSORIES

1

Furnished Accessories

This equipment is supplied with the following accessories.

Accessories	Q'ty	Remarks
Measuring cord <i>BNC</i>	3	2 m
Power cord	2	
Fuse	2	
Operation manual	1	
Service manual	1	

Options (ordered separately)

1. OPTION 01: BB Amplitude Measurement Facility
2. OPTION 02: X-Y Recorder Output Facility
3. OPTION 03: Sweep Frequency
One frequency from 18 to 100 Hz.
4. OPTION 04: Receiver GP-IB
Direct plotting of CRT output
5. OPTION 05: Additional BB frequency.
One additional specified frequency, either 55.6 kHz or 27.8 kHz, is installed.

Optional Accessories (ordered separately)

1. IF Return Loss Bridge MR55A1
Bridge balance: ≥ 54 dB (45 to 190 MHz)
 2. BB Return Loss Bridge MR43A
Bridge balance: ≥ 55 dB (100 kHz to 20 MHz)
 3. Test Mobile
MB24A: Fixed horizontal type
MB23A: Tilt angle type
 4. Carrying Case
Aluminium coated hard case with caster
-

TRANSMITTER

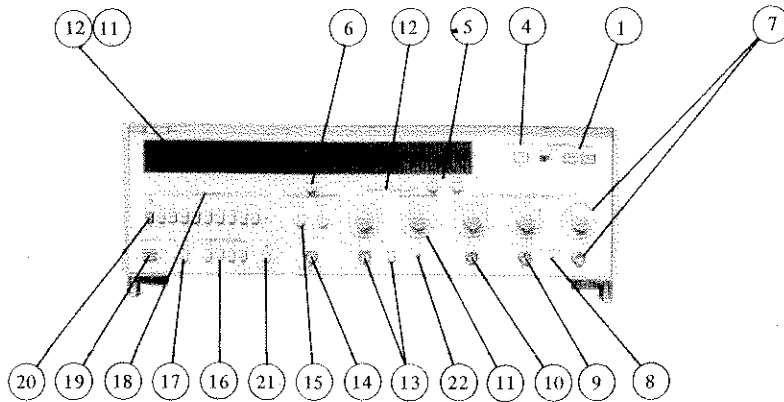

Front Panel

No.	Marking	Explanation
①	TRANSMITTER MODE	IF : Pushed when measuring IF to IF or IF to BB, for an IF device, demodulator, link, etc. BB : Pushed when measuring BB to IF and BB to BB, for a modulator, link, etc. IF BAND : 70 MHz/140 MHz band select switch.
④	BB SWEEPER	Pushed when measuring the amplitude characteristics of a BB device, link including modulator/demodulator, etc.
⑤	COARSE, FINE	Used to set the IF center frequency when the TRANSMITTER MODE key is in the IF position.
⑥	ADJUST	Set to SWEEP WIDTH \pm MHz when the TRANSMITTER MODE key is in the IF position. Set to the BB + SWEEP OUTPUT terminal sweep output voltage (volts peak/75 Ω) when the TRANSMITTER MODE key is in the BB position.
⑦	IF OUTPUT LEVEL dBm, IF OUTPUT	The level set on the OUTPUT dial is output from this terminal.
⑧	IF SLOPE ADJ	Used when changing the slope of the IF OUTPUT amplitude characteristic.
⑨	AUX IF OUTPUT	Provides -10 dBm fixed output at the same frequency as the IF OUTPUT signal. Used for IF RETURN LOSS measurement.
⑩	CRYSTAL OUTPUT	70 MHz or 140 MHz crystal oscillator output.
⑪	DEVIATION kHz rms	Used to set the FM deviation when the TRANSMITTER MODE key is in the IF position. The deviation is displayed on the panel.
⑫	BB OUTPUT LEVEL dBm	Sets the BB OUTPUT level when the TRANSMITTER MODE key is in the BB position or the BB SWEEPER ④ switch is pushed.

No.	Marking	Explanation
⑬	BB + SWEEP OUTPUT/BB OUTPUT	Selects composite signal of the BB signal and the sweep signal or the BB signal only.
⑭	SWEEP OUTPUT	A voltage equal to four times the value on the panel display set by ADJUST ⑥ is output for a 10 k Ω or more load when the TRANSMITTER MODE key is in the BB ② position.
⑮	BB SWEEPER FREQUENCY	The START knob is used to set the lower limit of the frequency sweep range and the STOP knob is used to set the upper limit.
⑯	SWEEP FREQUENCY	Switch for setting the sweep frequency.
⑰	SWEEP REDUCTION	When this switch is ON, the carrier sweep width is reduced automatically by the modulation frequency so that SWEEP WIDTH = carrier sweep width + modulation frequency. Where modulation frequency > 1 MHz.
⑱	BB FREQUENCY	Modulation frequency select switch.
⑲	POWER	Power switch.
⑳	AM-PM	Used when measuring the AM to PM conversion factor. When this switch is pushed, AM is applied to the IF output signal and a modulation frequency from 200 to 278 kHz is selected. However, the deviation must be set to 200 kHz rms when making this measurement.
㉑	LOW BB FREQUENCY (SWEEP 18 Hz)	Used when measuring with 55.6 kHz BB (or 27.8 kHz). When this switch is pressed, BB FREQUENCY ⑱ is disabled. Moreover, the sweep frequency automatically becomes 18 Hz without regard to the setting SWEEP FREQUENCY ⑯.
㉒	DEV ADJ	This knob adjusts the DEVIATION ⑪ display.

TRANSMITTER

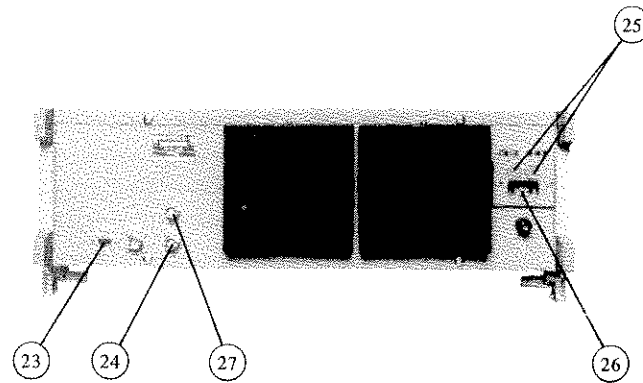

Rear Panel

No.	Marking	Explanation
②③	BB FREQ SELECT:	When this switch is set to INT, the transmitter is operated by the internal BB OSC selected with BB FREQUENCY ⑱. When this switch is set to EXT, the transmitter can be operated by an external oscillator. In the remote monitoring arrangement, connect the BB OUT on the rear panel of the receiver to EXT on the rear panel of the transmitter.

No.	Marking	Explanation
②④	EXT SWEEP FREQUENCY	When this is connected to an external oscillator and the EXT of switch ⑰ is pushed, the transmitter is operated by the external oscillator.
②⑤	FUSE	Fuse holder.
②⑥	AC**V	ac inlet.
②⑦	SWEEP OUTPUT	Output terminal for sweep signal (Output level is approx. 1 Vp-p)

Note: [*] indicates that the option is not equipped.

RECEIVER

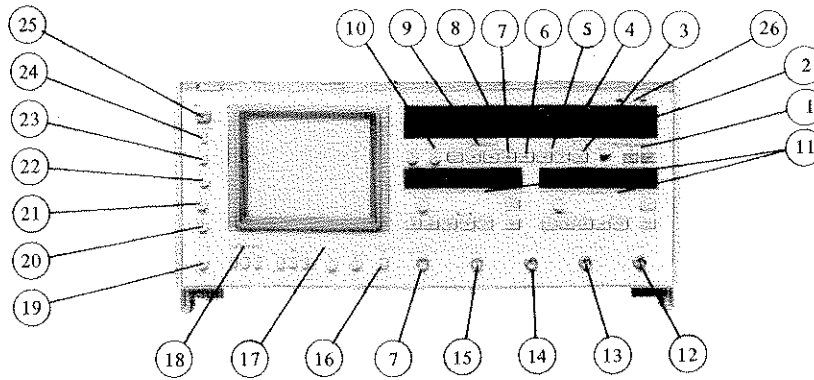

Front Panel

FRONT PANEL

No.	Marking	Explanation
①	RECEIVER MODE	<p>IF : Pushed when measuring IF to IF or BB to IF, for an IF device, modulator, link, etc.</p> <p>BB : Pushed when measuring BB to BB or IF to BB, for a demodulator, link, etc.</p> <p>IF BAND : IF band select switch.</p>
②	IF LEVEL dBm	Displays the -20 to +10 dBm IF input level. Flashes in case of overrange and underrange.
③	NORMLZR (Normalizer)	<p>Used for noise rejection and subtraction. When this key is pushed, the measured image on the CRT changes according to the function as follows:</p> <p>AVG (STO) (Average and stored):</p> <p>(i) Approximately 2 sec after the LED lights, averaging of CRT image begins and noise is rejected.</p> <p>(ii) Approximately 2 sec after the LED lights, the stored memory is held. If the NORMLZR key is pushed again within 2 sec, the stored memory is held and it is possible to shift to the next function.</p> <p>Y-STO (Y input signal minus stored signal):</p> <p>For example, accurate measurement with the inherent slope removed can be performed by storing the measurement system inherent slope with the AVG (STO) function and taking measurements with the Y-STO function.</p> <p>AVG-STO (Average Y input signal minus stored signal):</p> <p>This is used when the Y input signal is noisy. It has the same functions as Y-STO, except for improved measured image noise.</p>
④	BB FREQUENCY Hz	The received modulation frequency is indicated automatically by an LED. When the delay DP phase lock loop is not operating normally, the LED flashes.

No.	Marking	Explanation												
⑤	RANGE	<p>AUTO : The CRT sensitivity is adjusted automatically according to the measured waveform. Initial setup is this state.</p> <p>MANUAL : The CRT sensitivity is changed with the Y1 and Y2 RANGE keys.</p>												
⑥	P-P (peak to peak)	Displays the deviation (slope) of the measured image on the CRT - that is, it directly displays the peak-to-peak value.												
⑦	CAL	<p>DEVIATION : The CAL key is pushed to calibrate the deviation display after the SPECTRUM key is pushed and zero carrier on the CRT is confirmed. After calibration, set the CAL key to OFF.</p> <table border="1" data-bbox="912 1116 1378 1267"> <thead> <tr> <th>Type</th> <th>Modulation frequency</th> <th>Deviation</th> </tr> </thead> <tbody> <tr> <td>K</td> <td>200 kHz</td> <td>340 kHz rms</td> </tr> <tr> <td>L</td> <td>277.778 kHz</td> <td>472 kHz rms</td> </tr> <tr> <td>M</td> <td>250 kHz</td> <td>425 kHz rms</td> </tr> </tbody> </table> <p>RET LOSS : When the RET LOSS key is pressed, a bridge is connected to the MISMATCH 20 dB terminal. Then the CAL key is pressed and 20 dB appears on the Y1 LED and a return loss measurement system is calibrated.</p> <p>LOCAL : When this instrument is controlled through GPIB (option), this key switches REMOTE control to LOCAL control. See GPIB operation manual.</p>	Type	Modulation frequency	Deviation	K	200 kHz	340 kHz rms	L	277.778 kHz	472 kHz rms	M	250 kHz	425 kHz rms
Type	Modulation frequency	Deviation												
K	200 kHz	340 kHz rms												
L	277.778 kHz	472 kHz rms												
M	250 kHz	425 kHz rms												
⑧	BB LEVEL dBm DEVIATION kHz rms	The FM deviation is displayed when the RECEIVING MODE ① is in the IF position and the BB input level is displayed when the RECEIVING MODE ① is in the BB position.												
⑨	FREQ SELECT	<p>COUNTER : The CW IF signal frequency and the center frequency of the swept IF signal are measured and displayed on LEDs and the CRT. The sweep width of the swept IF signal is also displayed on the CRT.</p> <p>MARKER : The frequency of the sliding marker is displayed on LEDs and the CRT.</p>												

changed as indicated in the following Table

CRT Sensitivity

Items	Units of CRT Sensitivity	MANUAL Ranging								
		AUTO Ranging								
Linearity/DG	%/DIV		0.05	0.1	0.2	0.5	1.0	2.0	5.0	10
Group Delay	ns/DIV	0.1 (Y2)	0.5	1.0	2.0	5.0	10	20	50	
DP	DEG/DIV		0.2	0.5	1.0	2.0	5.0			
IF Amplitude	dB/DIV	0.01 (Y2)	0.05	0.1	0.2	0.5	1.0	2.0		
BB Amplitude	dB/DIV		0.1	0.2	0.5	1.0				
AM-PM Coefficient	°/dB/DIV		0.2	0.5	1.0	2.0				
Return Loss (IF)	dB/DIV	1, 5 dB/div	Center of scale: 14 to 46, 1 dB steps, 1 dB/div (Range: 10 to 50 dB)							
DC	mV/DIV	1 2 5 10 20 50 100								
Spectrum	/DIV	0.25								

(10) NORMLZR (Normalizer)

Measuring example (subtraction)

Step 1

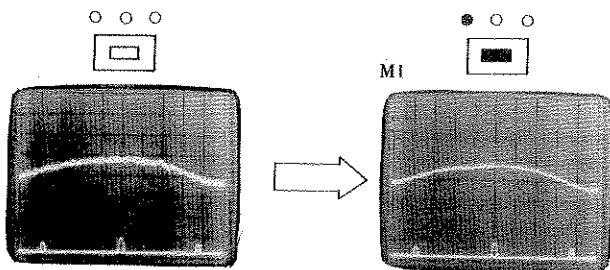

After 2 seconds, the averaging and storing functions operate

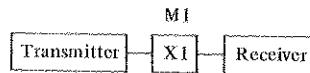

Step 2



Step 3 Insert the X2 device under test into measuring line.

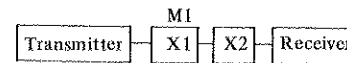
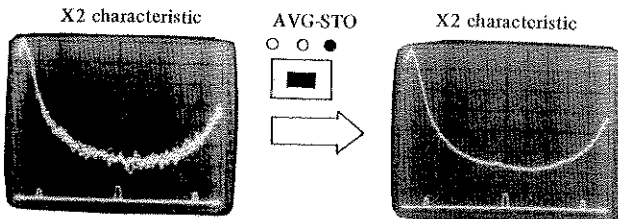

Check 1 M1 observation time is only 2 seconds.

M1 characteristic can be observed by pushing the NORMLZR key (AVG(STO)) but after 2 sec. the M1 characteristic is

Note: BLANKING-ON

The retrace is not averaged

(7) SCALE INTEN (Scale intensity)

When photographing the CRT screen, the scale can be made to appear clearly as shown below by setting the SCALE INTEN switch to ON (pushed).

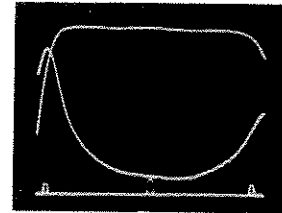
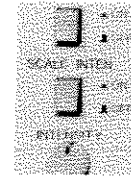

SCALE INTEN-OFF

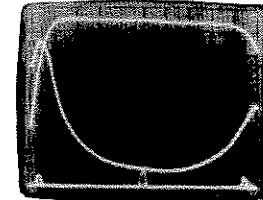

SCALE INTEN-ON

(8) P-P (peak to peak)

The size of the measured image is displayed directly.

example

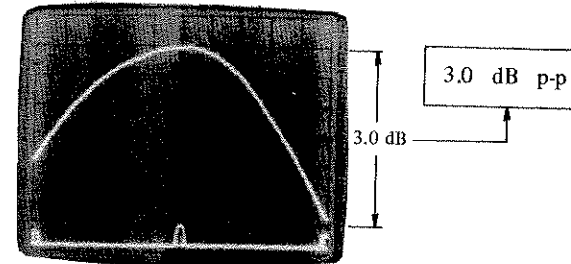

(9) SWEEP REDUCTION



See item (17) of the operation panel explanation on page 2.

When the modulation frequency (BB FREQUENCY) is above 1 MHz, the carrier sweep width is reduced by this frequency. (However, the amplitude of the SWEEP + BB OUTPUT and SWEEP OUT sweep signal is not reduced.) Care must be taken since the transmitter sweep width display and sweep width by receiver marker are different by the value of the modulation frequency. (The marker indicates only the carrier sweep component.)

(10) X PHASE and X SELECT

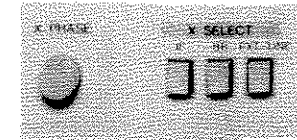

See item (16) of the operation panel explanation on page 3. When BB and EXT/LINE are selected, a variable phase width of 360° or more is obtained. However, when IF is selected, the horizontal phases are almost matched and the X PHASE variable width is small.

(11) SWEEP OUTPUT



See item (14) of the operation panel explanation on page 2. When the load is 10 kΩ or greater, the voltage output to the load is four times the value indicated on the panel.

For example, when

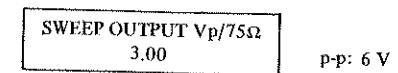

the output voltage becomes

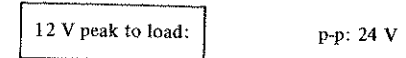

(12) FM DEVIATION

Transmitter accuracy: within ±10%

Receiver accuracy: within ±10%

(High accuracy measurement by the Receiver is possible by performing the CALIBRATION described on page 12 and 22.)

DEV ADJ

This is used to set the TRANSMITTER FM DEVIATION displayed value to the RECEIVER measured value. Setting range is approximately ±10%.

Power to be supplied to the Microwave System Analyzer should be as follows:

- Power voltage: AC 100 V to 127 V, 200 V to 254 V.
The power voltage is set by the manufacturer to the value specified by the Customer.
- Power capacity: Approx. 260 VA
- Power frequency tolerance: 48 Hz to 66 Hz

Before turning on the power, make sure that the power supply voltage is within $\pm 10\%$ of the rated voltage value which is shown on the rear panel.

A few minutes after power is turned on, measurement can begin.

Ground the measuring equipment and the units to be measured. Otherwise, voltage may be generated between their frames.

(2) MODE (Transmitter and receiver mode)



For example, when measuring a demodulator (IF to BB), push the TRANSMITTER MODE IF and RECEIVER MODE BB switches. The parameters needed for measurement will be displayed on the panel.

TRANSMITTER MODE

- IF : DEVIATION kHz rms, SWEEP WIDTH \pm MHz, IF CENTER FREQ MHz, (IF OUTPUT LEVEL dBm)
- BB : BB OUTPUT dBm, SWEEP OUTPUT Vp/75 Ω

RECEIVER MODE

- Common : SLIDE MARKER \pm MHz, IF LEVEL dBm
- IF : DEVIATION kHz rms
- BB : BB LEVEL dBm

(3) CAL (Calibration)

See item ⑦ of the operation panel explanation of front panel on page ③.



DEVIATION: This key operates when the SPECTRUM Y2-SPECTRUM key has been pushed, the modulation frequency conforms to the table below and the CRT carrier zero (2.405 radian) was performed correctly (within approx. 30%).

Type	Modulation frequency	Calibration factor
K	66.667 kHz	113 kHz rms
	200 kHz	340 kHz rms
	92.593 kHz	157 kHz rms
L	277.778 kHz	472 kHz rms
	83.333 kHz	142 kHz rms
M	250 kHz	425 kHz rms

RET. LOSS : Effective only for the RETURN LOSS function. The internal calibration factor is 20 dB, but can be changed with Y1 RANGE keys.

Split trace : If this key is pushed when the linearity, DG, delay, DP, or BB ampl function is being performed, the internal calibrator causes two lines to appear on the CRT.

Between of : Linearity/DG-10% Delay-10ns DP-1° BB

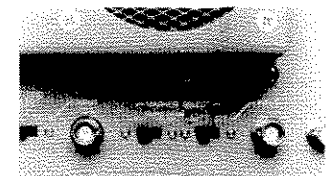

SLIDE : A side marker that slides as shown below is displayed on the CRT. The marker frequency is displayed on the panel.

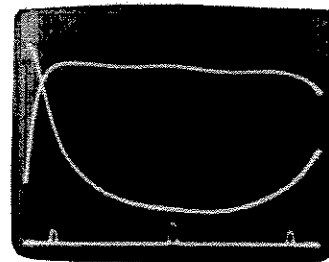

2 MHz COMB + SLIDE : The 2 MHz interval comb markers and the sliding side marker are displayed simultaneously on the CRT shown below.

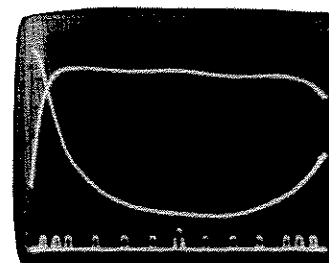

CHECK : Used to confirm that the right side of the X-axis (frequency) is high frequency.

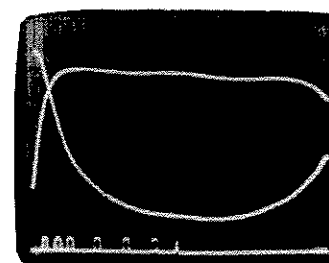

No.	Marking	Explanation
(10)	MARKER	<p>POSITION : Moves the marker reference line up and down.</p> <p>FREQUENCY : Sliding side marker frequency controller.</p> <p>SLIDE MARKER \pm MHz : Sliding side marker frequency.</p> <p>CHECK (Polarity check) : When this key is pushed, a half of the marker train at high frequency is extinguished. In the opposite case, change the CRT X-phase by using X PHASE (19).</p>

Y1, Y2		Units	
Key	Item	RANGE	P-P
LINEARITY DG.	Linearity Differential Gain	% /DIV	% P-P
DELAY	Group Delay (modulation frequency < 1 MHz)	ns /DIV	ns P-P
DP	Differential phase (modulation frequency > 1 MHz)	DEG /DIV	DEG P-P
AMPL	Amplitude Response	dB /DIV	dB P-P
RET LOSS	Return Loss	dB /DIV 1dB/DIV	—
AM-PM	AM to PM Conversion coefficient	%/dB /DIV	%/dB P-P
DC	DC input level	mV /DIV	—
SPECTRUM	Frequency spectrum	—	—

POSITION : Moves the Y1 and Y2 images up and down.

RANGE: Operates when RANGE (5) is in MANUAL mode.

(12)	IF INPUT	Input terminal for IF signal measurement.
(13)	RETURN LOSS INPUT	Used in IF band return loss measurement. Receives a small amount of power from the IF return loss bridge.
(14)	BB INPUT	Input terminal for BB signal measurement.
(15)	DC INPUT	Input terminal for DC voltage measurement.
(16)	PLOT	The measurement parameters and result on the CRT are output directly to the plotter/printer and not through the controller. When plotting was started by setting this switch to ON and

No.	Marking	Explanation
(17)	X-Y RECORDER OUTPUT	<p>A hard copy of the measured image on the CRT can be made by connecting the rear panel X, Y OUTPUT terminals (4) to an X-Y recorder.</p> <p>40 SEC, 20 SEC : Pen speed select switch.</p> <p>CAL : A spot appears at the right top and left bottom corners of the CRT scale and a signal corresponding to these spots is simultaneously output from the X, Y output terminals. This output is used to calibrate X-Y recorder sensitivity and position.</p> <p>MEAS : Set this switch to MEAS when the calibration of X-Y recorder is completed.</p> <p>START, WRITE : Pushed to start a hard copy. During the operation of hard copy, WRITE LED lights up.</p> <p>X GAIN, Y GAIN : Used to set the sensitivity of X-Y recorder.</p>

(18)	X SELECT	<p>CRT horizontal axis selector switch.</p> <p>IF : The X-axis is produced by reproducing the X-axis component from the swept IF signal from the IF INPUT terminal.</p> <p>BB : The X-axis is produced by detecting the X-axis component from the BB input signal. At this time, the BB input signal must contain a horizontal signal.</p> <p>EXT/LINE : Used to select an external signal or ac line signal. The desired signal is selected with the rear panel EXT/LINE selector.</p>
------	----------	---

(19)	X PHASE	Horizontal phase adjuster.
(20)	X POSITION	Horizontal position adjuster.
(21)	X GAIN	Horizontal signal gain adjuster.
(22)	INTENSITY	CRT intensity adjuster.
(23)	SCALE INTEN	Used when photographing the CRT image. Varies the CRT brightness.
(24)	BLANKING	Switch for blanking the fly-back line of the horizontal-axis sweep of the CRT.
(25)	POWER	Power switch.

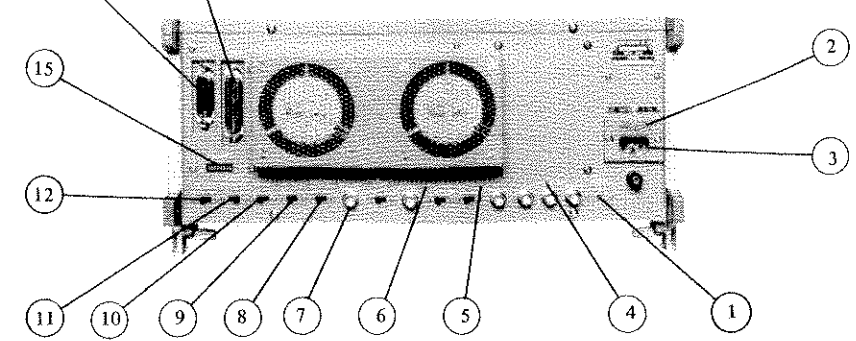

Rear Panel

No.	Marking	Explanation
(1)	TRACE ROTATION	Adjusts the horizontal axis tilt.
(2)	FUSE	Fuse holder.
(3)	AC **V	ac inlet
(4)	X-Y RECORDER OUTPUT	Used to output the measured image on the CRT to an X-Y recorder. The switches (15) on the front panel control this output.
(5)	MARKER SELECT	<p>INT : Normally set in this state.</p> <p>EXT : Used when detecting the marker with an external detector.</p> <p>SLIDE : Slide marker</p> <p>2 MHz COMB + SLIDE : A marker combining the 2 MHz interval comb marker and slide marker is output.</p>
(6)	EXT/LINE SELECT	<p>Effective when front panel X SELECT (18) is set to EXT/LINE.</p> <p>EXT : Used when an external oscillator is used.</p> <p>LINE : Used when the horizontal signal is synchronized with the ac line signal.</p>
(7)	BB OUTPUT	BB output terminal for remote monitoring. Connects to BB FREQ SELECT-EXT on the rear panel of the transmitter.
(8)	THRESHOLD EXTENSION	Filter switch to protect the discriminator when the IF signal contains mush noise.

No.	Marking	Explanation
(9)	CRT TRACE	<p>CHOP (chopping) : The Y1 and Y2 marker multitrace display is chopped at high speed. Use in normal measurement.</p> <p>ALT (Alternate) : Switches the Y1 and Y2 and marker at each X-axis sweep. When measuring an especially sharp characteristic, a clear measured image is obtained, but if the sweep frequency is low, the image flickers.</p>
(10)	PLL CUT FREQ (Phase locked loop cut frequency)	<p>HIGH : Set when the sweep frequency is 20 Hz or higher. The group delay detection response is fast.</p> <p>LOW : Set when the sweep frequency is under 20 Hz. The group delay detection response is slow, but the correct measured value is obtained.</p>
(11)	CHARACTER	<p>ON : The measurement parameters and result are plotted numerically displayed on the CRT.</p> <p>OFF : The measurement parameters and result are not displayed.</p>
(12)	BB SELECT	<p>55.6 k (27.8 k) Hz : Set when measuring at low BB frequency 55.6 kHz (or 27.8 kHz).</p> <p>NORMAL : Normally set to this position.</p>
(13)	GP-IB	GP-IB connector
(14)	PLOTTER INTERFACE	8-bit parallel interface connector

NO.	MARKING	EXPLANATION
⑮	TALK ONLY OFF ON	This is the GP-IB address settable state. The address is set with the GP-IB ADDRESS switches. This instrument is fixed as the talker without regard to the setting of the GP-IB address switches. (Used when plotting directly at the plotter-printer without going through the controller.)
	GP-IB ADDRESS	These switches set the GP-IB address of this instrument. Thirty-one addresses from 0 to 30 can be selected.
	PLOTTER SELECT	When plotting directly at the plotter without going through the controller, this switch must be selected according to the kind of plotter.

Note: indicates that the option is not equipped.

Rear Panel of Receiver

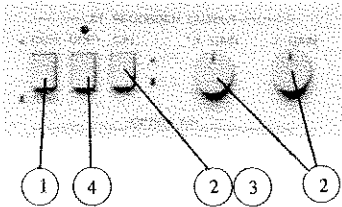
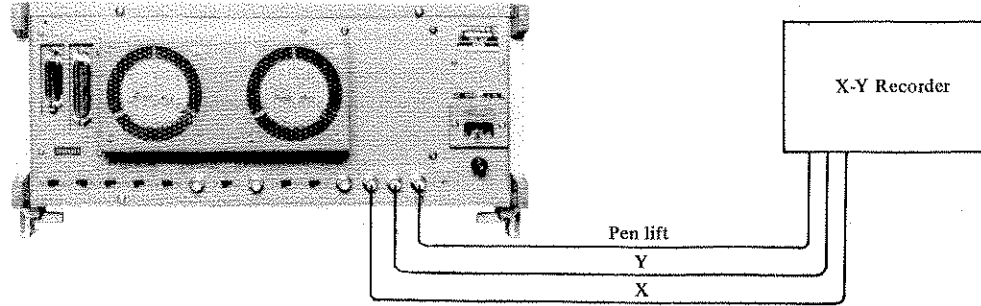

Set the controls as follows.

- ① 40 sec, 20 sec : Pen speed selector. Set to required speed.
- ② CAL : CAL. Adjust the upper pen position by turning the X, Y GAIN knobs.

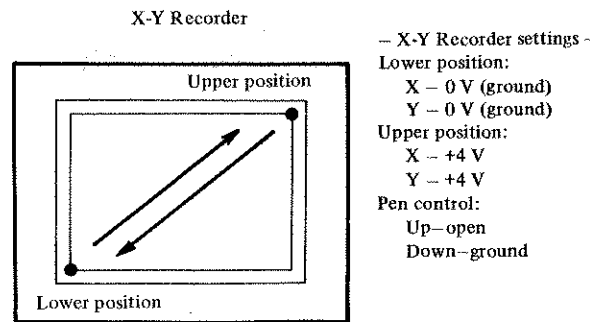

- X-Y Recorder settings -
 Lower position:
 X - 0 V (ground)
 Y - 0 V (ground)
 Upper position:
 X - +4 V
 Y - +4 V
 Pen control:
 Up - open
 Down - ground

LOWER POSITION : CAL ②
 UPPER POSITION : CAL ②

- ③ CAL :
- ④ COPY : Push. X-Y Recorder starts to copy the characteristic.

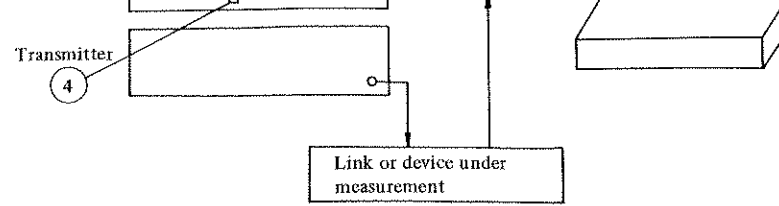

Set the controls as follows.

- ① Connect the Receiver GP-IB or PLOTTER INTERFACE connector on the rear panel and the plotter/printer.
- ② GP-IB ADDRESS : Set in accordance with Table (a). (rear panel)
- ③ Plotter/Printer : Set the pens, paper and listen only.

Pens used

I. Plotter DPL7716A (Anritsu), 9872C (HP), VP6801A (Matsushita)

Pen	Description
No. 1	Measurement parameter, scale
No. 2	Y1 measured trace
No. 3	Y2 measured trace

II. Plotter : 7470A (HP)

Pen	Description
No. 1	Measurement parameter, scale
No. 2	Y1 measured trace
No. 1	Y2 measured trace

- ④ PLOT : ON
- REMOTE lamp ⑤ : light up (Indicates Receiver is in REMOTE mode. Panel operation is impossible)

Table (a) GP-IB ADDRESS Setting

TALK ONLY	ADDRESS switch						PLOTTER SELECT	Interface	Description
	GP-IB ADDRESS								
	5	4	3	2	1	2			
1	/	/	/	/	/	0	0	GP-IB	PLOTTER VP6801A (Matsushita)
1						0	1	PLOTTER DPL7716A (Anritsu)	
1						1	0	PLOTTER 9872C, 7470A (HP)	
1						1	1	PRINTER DPR7713A (Anritsu)	
0	/	/	/	/	/	0	0	8 bit parallel (Conforms to Centronic)	PLOTTER VP6801A (Matsushita)
0						0	1		Not use
0						1	0		Not use
0						1	1		PRINTER DPR7713A (Anritsu)

Notes:

- (1) When the PLOT switch is pressed again during plotting, plotting is interrupted.
- (2) When plotting is interrupted, the plotter/printer plots all the data received up to that point, then stops. Therefore, it take 10 seconds or longer for the plotter/printer to stop.
- (3) When plotting was interrupted, reset the plotter/printer before using it again.

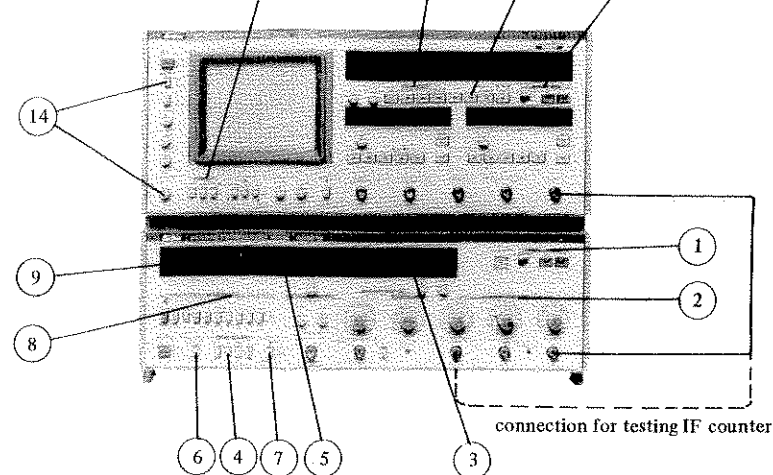
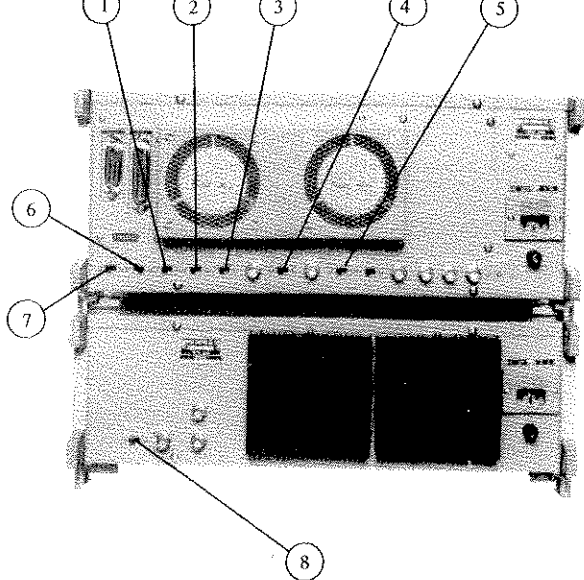

5

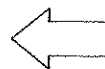

Presetting the REAR PANEL

**IF to IF (Connect the IF OUTPUT to the IF INPUT directly)
Set the controls as follows:**

①	PLL CUT FREQ	HIGH	Set to LOW when sweep frequency is less than 20 Hz.
②	CRT TRACE	ALT	Set to CHOP when sweep frequency is low (\leq approx. 20 Hz) to obtain a clear trace line.
③	THRESHOLD EXTENSION	OFF	Set to ON when there is much noise in the IF input signal. However, the modulation frequency must be less than 556 kHz.
④	EXT/LINE SELECT	LINE	Set to EXT when using an external sweep signal.
⑤	MARKER SELECT	INT, SLIDE	Set to EXT when using an external frequency marker detector.
⑥	CHARACTER	ON	Set to OFF when desiring to erase the alphanumeric characters displayed on the CRT.
⑦	BB SELECT	NORMAL	Set to 55.6 kHz (27.8 kHz) when making measurements at LOW BB (55.6 kHz or 27.8 kHz).
⑧	BB FREQ SELECT	INT	Set to EXT when using an external oscillator.

TRANSMITTER:	
①	TRANSMITTER MODE
	IF BAND 70 or 140 MHz (for ME538K/L/M).
	BB, IF IF.
②	IF OUTPUT LEVEL dBm 0 dBm.
③	IF CENTER FREQ MHz 70 MHz or 140 MHz.
④	SWEEP FREQUENCY LINE.
⑤	SWEEP WIDTH \pm MHz 25 MHz/70 MHz BAND or 50 MHz/140 MHz BAND
⑥	SWEEP REDUCTION AUTO <input type="checkbox"/>
⑦	LOW BB FREQUENCY OFF <input type="checkbox"/>
⑧	BB FREQUENCY Hz 200 kHz, 278 kHz or 250 kHz for Delay, Linearity Measurement. 5.6 MHz for DG, DP Measurement.
⑨	DEVIATION kHz rms 200 kHz rms for Delay Linearity Measurement. 500 kHz rms for DG, DP Measurement.
RECEIVER:	
⑩	RECEIVER MODE
	IF BAND 70 or 140 MHz.
	BB, IF IF.
⑪	RANGE AUTO.
⑫	FREQ SELECT MARKER, FREQUENCY : Set to \pm 25 MHz/70 MHz BAND or \pm 50 MHz/140 MHz BAND
⑬	X SELECT IF.
⑭	X PHASE Adjust the knob to coincide the tracing marker pulses with the retracing marker pulse while the BLANKING is OFF. After adjusting, set the BLANKING

IF LEVEL

If the difference between the IF OUTPUT LEVEL and IF INPUT LEVEL is less than 0.6 dB, IF LEVEL is normal.

IF AMPLITUDE

- (a) Y1 selectors AMPL
Y2 selectors OFF

If the item key- LEDs light, push these keys again. The LEDs turn off and these function enters the OFF state.

- (b) Confirmation: The slope should be less than ± 0.05 dB/70 ± 25 MHz, ± 0.2 dB/140 ± 50 MHz.

Note: SLOPE ADJ is used for compensation of the cable characteristics.

GROUP DELAY & LINEARITY

- (a) (Transmitter) Set as follows.
BB FREQ:

Type K 200 kHz.
Type L 278 kHz.
Type M 250 kHz.

- (b) (Transmitter) DEVIATION: 200 kHz rms.

- (c) Y1 selectors: DELAY/DP.

- (d) Confirmation: The slope of the trace should be less than 0.5 ns/70 ± 25 MHz, 1 ns/140 ± 50 MHz.

- (e) Y2 selectors: LINEARITY/DG.

- (f) Confirmation: The slope should be less than 0.2%/70 ± 25 MHz, 0.2%/140 ± 50 MHz.

Differential Phase & Differential Gain

- (a) (Transmitter) BB FREQ: Set to 5.6 MHz

- (b) (Transmitter) DEVIATION: 500 kHz rms.

- (c) Y1 selectors: DELAY/DP.

- (d) Confirmation: The slope should be less than $0.5^\circ/70 \pm (25 - \text{BB FREQ})$ MHz, $0.8^\circ/140 \pm (50 - \text{BB FREQ})$ MHz.

- (e) Y2 selectors: LINEARITY/DG.

- (f) Confirmation: The slope should be less than 0.4%/70 $\pm (25 - \text{BB FREQ})$ MHz, 0.6%/140 $\pm (50 - \text{BB FREQ})$ MHz.

IF counter

- (a) Connect the CRYTAL OUTPUT to the IF INPUT directly.

- (b) FREQ SELECT (12): COUNTER

- (c) Confirmation: The FREQUENCY measured value is within 70 MHz ± 10 kHz or 140 MHz ± 20 kHz.

BB to BB (connect the BB OUTPUT to the BB INPUT directly)

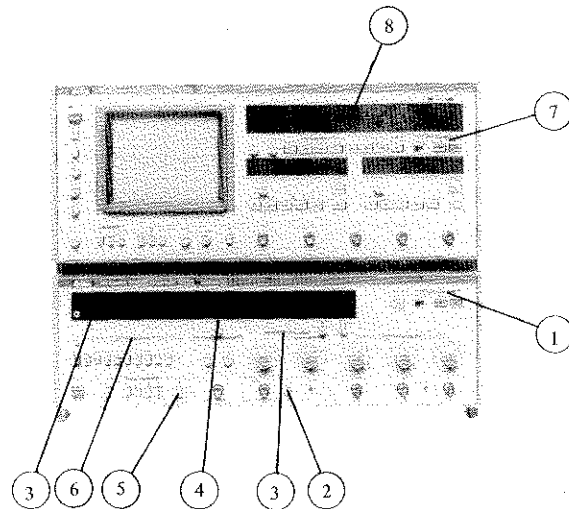

Set the controls as follows:

TRANSMITTER:

- | | | |
|---|------------------|---|
| ① | TRANSMITTER MODE | BB. |
| ② | (OUTPUT SELECT) | BB OUT <input type="checkbox"/> |
| ③ | BB OUTPUT LEVEL | 0 dBm. |
| ④ | SWEEP OUTPUT | zero. |
| ⑤ | LOW BB FREQUENCY | OFF <input type="checkbox"/> |
| ⑥ | BB FREQUENCY | Push the keys in sequence, after RECEIVER settings. |

RECEIVER:

- | | | |
|---|---------------|-----------------|
| ⑦ | RECEIVER MODE | BB. |
| ⑧ | BB LEVEL dBm | Read the level. |

BB LEVEL

If the difference between BB OUTPUT level and BB LEVEL is less than 0.6 dB, BB level is normal.

Other BB to BB characteristics

If the IF to IF characteristics are normal, BB to BB measurement facilities are normal.

7

IF TO IF (IF device, link and so forth)

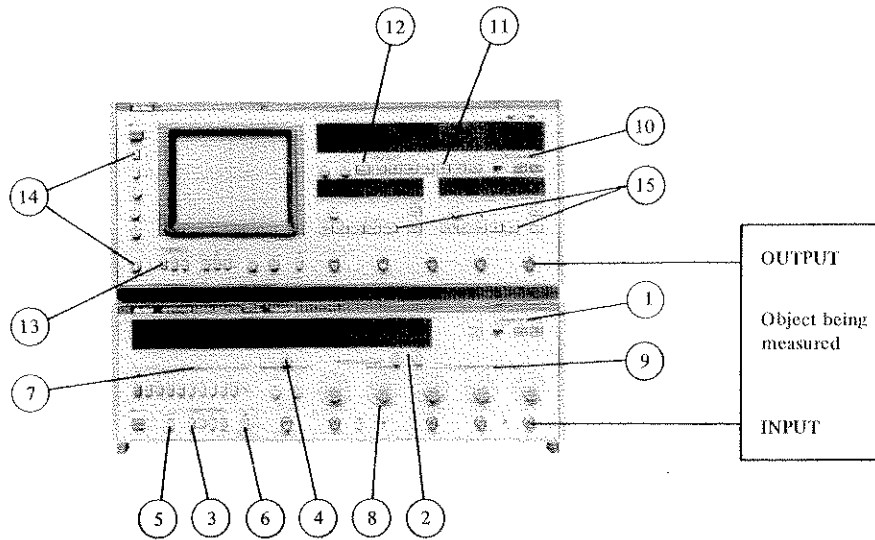

5



Presetting the REAR PANEL
Set the controls as follows:

TRANSMITTER:		
①	TRANSMITTER MODE	
	IF BAND	Required IF band. (70 MHz or 140 MHz)
	BB, IF	IF.
②	IF CENTER FREQ	Required center frequency.
③	SWEEP FREQUENCY	LINE.
④	SWEEP WIDTH ±MHz	Required sweep width.
⑤	SWEEP REDUCTION	Push AUTO <input type="checkbox"/> if the automatic sweep reduction function is required.
⑥	LOW BB FREQUENCY	OFF <input type="checkbox"/>
⑦	BB FREQUENCY Hz	Required modulation frequency. For Delay measurement, set the BB frequency to less than 1 MHz, for DG and DP measurements, set the BB frequency more than 1 MHz (≤ 8.2 MHz).
⑧	DEVIATION kHz rms	200 kHz rms for Delay measurement. 500 kHz rms for DG and DP measurements.
⑨	IF OUTPUT LEVEL dBm	Level specified by application.
RECEIVER		
⑩	RECEIVER MODE	
	IF BAND	Required band. (70 MHz or 140 MHz)
	BB, IF	IF.
⑪	RANGE	AUTO.
⑫	FREQ SELECT	MARKER, FREQUENCY : Set the frequency to observing band width.
⑬	X SELECT	IF.
⑭	X PHASE, BLANKING	Adjust the knob to coincide the tracing marker pulse with the retracing marker pulse while the BLANKING switch is OFF. After adjusting, set the BLANKING switch to ON.
⑮	Measurements	Push the Y1, Y2 measuring item keys.

IF TO IF

(1) Group Delay Measurement

- (a) Y1 keys DELAY/DP.
- (b) Confirm that modulation frequency is less than 1 MHz and deviation is about 200 kHz rms.
- (c) Scale sensitivity is displayed in ns/DIV.

(2) IF Amplitude Measurement

- (a) Y1 keys AMPL.
- (b) Caution: To measure characteristics with steep slope, lower FM deviation or set it to zero.
- (c) Scale sensitivity is displayed in dB/DIV.

Note: Detected amplitude signal is dc-coupled to CRT in the 1 dB/DIV and 2 dB/DIV scale sensitivities.

(3) Differential Phase Measurement

- (a) Y1 keys DELAY/DP.
- (b) Confirm that modulation frequency is more than 1 MHz (≤ 8.2 MHz), and FM deviation is about 500 kHz rms.

Note: To convert to delay time, use the equation below:

$$\tau \text{ (ns)} = \frac{\text{DP (degree)}}{0.36 \times \text{fm (MHz)}}$$

Table of conversion of group delay and the differential phase calculated through the equation above is shown in Appendix [25].

- (c) Scale sensitivity is displayed in DEG/DIV.

(4) Differential Gain Measurement

- (a) Y1 keys LINEARITY/DG.
- (b) Confirm that modulation frequency is more than 1 MHz (≤ 8.2 MHz), and FM deviation is about 500 kHz rms.
- (c) Scale sensitivity is displayed in %/DIV.

(5) Dual Trace Display

- (a) Key in the two measurement items to be simultaneously measured at Y1 and Y2.
- (b) Dual trace display of measurement items having respective different modulation frequencies, such as delay and DP measurement items for example, is impossible.

Note: For dual trace display including measurement of return loss, see paragraph [15].

BB TO IF (Modulator, link included)

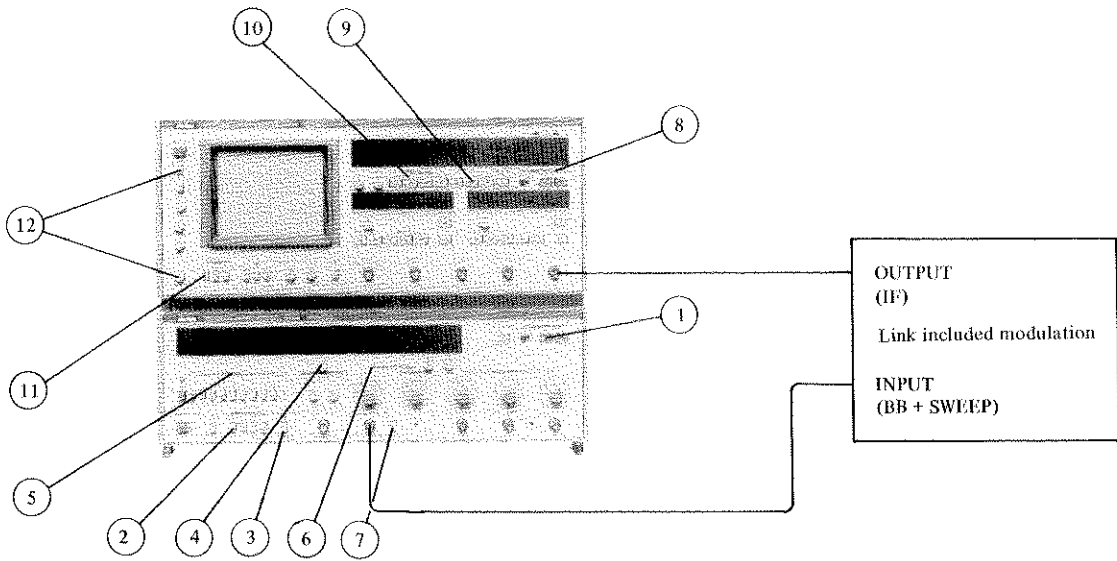

5 ← **Presetting the REAR PANEL**

Set the control as follows:

TRANSMITTER:	
① TRANSMITTER MODE	BB.
② SWEEP FREQUENCY	LINE.
③ LOW BB FREQUENCY	OFF <input checked="" type="checkbox"/>
④ SWEEP OUTPUT V _p /75Ω	Set the voltage using the following equation. $\text{Volts peak} = \frac{\text{Sweep width (Hz P-P)}}{2} \times \frac{\text{test tone level of test point (V}_{\text{rms}}/75\Omega)}{\text{test tone deviation of test point (Hz rms)}}$ It is convenient to set the voltage by IF sweep width.
⑤ BB FREQUENCY	Required modulation frequency. For Linearity and Delay measurement, set the BB frequency to less than 1 MHz, for DG and DP measurement, set the BB frequency to more than 1 MHz (≤ 8.2 MHz).
⑥ BB OUTPUT LEVEL dBm	Set level corresponds to FM deviation 200 kHz rms for Linearity and Delay measurement, or FM deviation 500 kHz rms for DG and DP measurement.
⑦ (OUTPUT SELECT)	BB + SWEEP OUTPUT <input checked="" type="checkbox"/>
RECEIVER	
⑧ RECEIVER MODE	
IF BAND	Required band.
BB, IF	IF
⑨ RANGE	AUTO.
⑩ FREQ SELECT	MARKER, FREQUENCY : Set the frequency to the frequency to the observing bandwidth.
⑪ X SELECT	IF.
⑫ X PHASE, BLANKING	Adjust the knob to coincide the tracing marker pulse with the retracing marker pulse while the BLANKING switch is OFF. After adjusting, set the BLANKING switch to ON.
⑬ Measurements	Push the Y1, Y2 measuring item keys.

modulator, and so forth) BB TO IF

(1) Group Delay Measurement

- (a) Y1 keys DELAY/DP.
- (b) Confirm that modulation frequency is less than 1 MHz and deviation is about 200 kHz rms.
- (c) Scale sensitivity is displayed in ns/DIV.

(2) Linearity Measurement

- (a) Y1 keys LINEARITY/DG.
- (b) Confirm that modulation frequency is less than 1 MHz and deviation is about 200 kHz rms.
- (c) Scale sensitivity is displayed in %/DIV.

(3) IF Amplitude Measurement

- (a) Y1 keys AMPL.
- (b) Caution: To measure characteristics with steep slope, lower FM deviation or set it to zero.
- (c) Scale sensitivity is displayed in dB/DIV.

Note: Detected amplitude signal is dc-coupled to the CRT in the 1 dB/DIV and 2 dB/DIV scale sensitivities.

(4) Differential Phase Measurement

- (a) Y1 keys DELAY/DP.
- (b) Confirm that modulation frequency is more than 1 MHz (≤ 8.2 MHz), and FM deviation is about 500 kHz rms.

Note: To convert to delay time, use the equation below:

$$\tau \text{ (ns)} = \frac{\text{DP (degree)}}{0.36 \times \text{fm (MHz)}}$$

A conversion table for group delay and the differential phase calculated using the above equation is given in Appendix [\[25\]](#).

(5) Differential Gain Measurement

- (a) Y1 keys LINEARITY/DG.
- (b) Confirm that modulation frequency is more than 1 MHz (≤ 8.2 MHz), and FM deviation is about 500 kHz rms.
- (c) Scale, sensitivity is displayed in %/DIV.

(6) Dual Trace Display

- (a) Key in the two measurement items to be simultaneously measured at Y1 and Y2.
- (b) Dual trace display of measurement items having respective different modulation frequencies, such as delay and DP measurement items for example, is impossible.

Note: For dual trace display including measurement of return loss, see paragraph [\[15\]](#).

IF TO BB (Demodulator, link included)

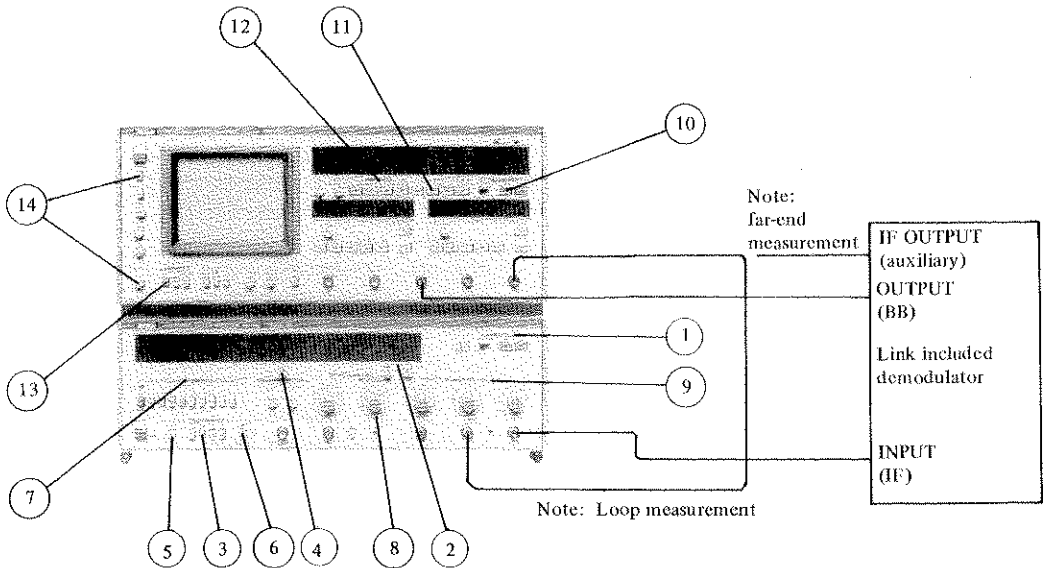

5 ← **Presetting the REAR PANEL**
set the controls as follows:

TRANSMITTER:	
①	TRANSMITTER MODE
	IF BAND Required IF band. (70 MHz or 140 MHz)
	BB, IF IF.
②	IF CENTER FREQ Required center frequency.
③	SWEEP FREQUENCY LINE.
④	SWEEP WIDTH ±MHz Required sweep width.
⑤	SWEEP REDUCTION Push AUTO <input type="checkbox"/> if the automatic sweep reduction function is required.
⑥	LOW BB FREQUENCY OFF <input type="checkbox"/>
⑦	BB FREQUENCY Hz Required modulation frequency. For Delay measurement, set the BB frequency to less than 1 MHz, for DG and DP measurements, set the BB frequency more than 1 MHz (≤ 8.2 MHz).
⑧	DEVIATION kHz rms 200 kHz rms for Delay and Linearity measurements, 500 kHz rms for DG and DP measurements.
⑨	IF OUTPUT LEVEL dBm Level specified by application.
RECEIVER:	
⑩	RECEIVER MODE BB.
⑪	RANGE AUTO.
⑫	FREQ SELECT MARKER, FREQUENCY : Set the frequency to observing bandwidth.
⑬	X SELECT IF. (Refer to note 1)
⑭	X PHASE, BLANKING Adjust the knob to coincide the tracing marker pulse with the retracing marker pulse while the BLANKING switch is OFF. After adjusting, set the BLANKING switch to ON.
⑮	Measurements Push Y1, Y2 measuring keys. Do not select the AMPL and RET. LOSS keys. (If BB SWEEPER option 01 is installed, oscillation of the X axis on the CRT will stop.)

demodulator, and so forth) IF TO BB

Note 1: For end to end measurement, horizontal-axis signal and frequency marker can be obtained by supplying the signal branched from the IF section of the object being measured to the IF INPUT connector. If this branching is difficult, set the X SELECT to BB. However, in this case, the BB INPUT input signal must include the sweep frequency component.

(1) Group Delay Measurement

- (a) Y1 keys DELAY/DP.
- (b) Confirm that modulation frequency is less than 1 MHz and deviation is about 200 kHz rms.
- (c) Scale sensitivity is displayed in ns/DIV.

(2) Linearity Measurement

- (a) Y1 keys LINEARITY/DG.
- (b) Confirm that modulation frequency is less than 1 MHz and deviation is about 200 kHz rms.
- (c) Scale sensitivity is displayed in %/DIV.

(3) Differential Phase Measurement

- (a) Y1 keys DELAY/DP.
- (b) Confirm that modulation frequency is more than 1 MHz (≤ 8.2 MHz), and FM deviation is about 500 kHz rms.

Note: To convert to delay time, use the equation below:

$$\tau \text{ (ns)} = \frac{\text{DP (degree)}}{0.36 \times \text{fm (MHz)}}$$

A conversion table for group delay and the differential phase calculated with the above equation is given in Appendix [25].

- (c) Scale sensitivity is displayed in DEG/DIV.

(4) Differential Gain Measurement

- (a) Y1 keys LINEARITY/DG.
- (b) Confirm that modulation frequency is more than 1 MHz (≤ 8.2 MHz), and FM deviation is about 500 kHz rms.
- (c) Scale sensitivity is displayed in %/DIV.

(5) Dual Trace Display

- (a) Key in the two measurement items to be simultaneously measured at Y1 and Y2.
- (b) Dual trace display of measurement items having respective different modulation frequencies, such as delay and DP measurement items for example, is impossible.

Note 2: For dual trace display including measurement of return loss, see paragraph [15].

BB TO BB (Link included modulator and

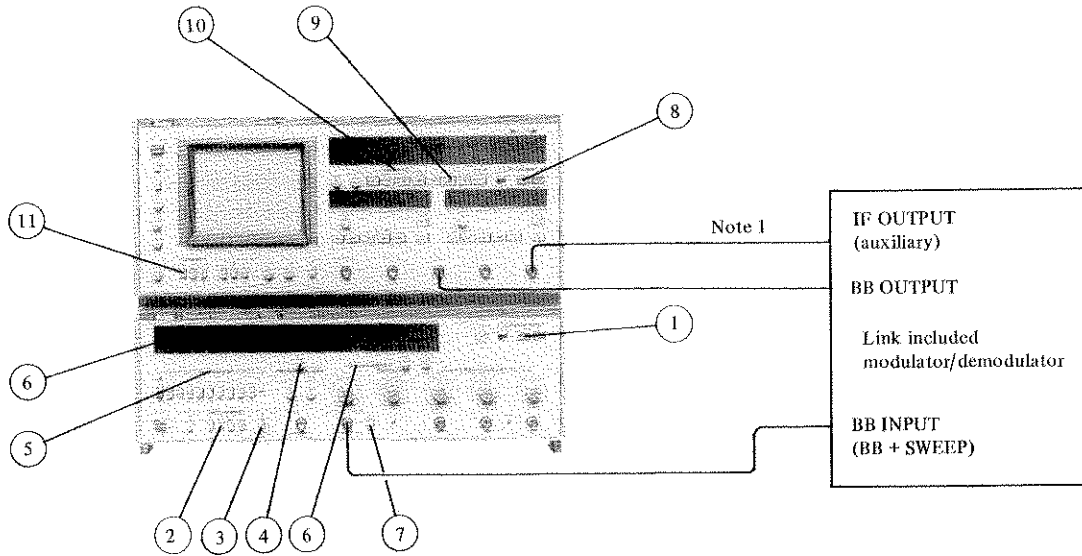

5

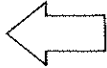

Presetting the REAR PANEL

Set the controls as follows:

TRANSMITTER:	
① TRANSMITTER MODE	BB, IF BB.
② SWEEP FREQUENCY	LINE.
③ LOW BB FREQUENCY	OFF <input checked="" type="checkbox"/>
④ SWEEP OUTPUT $V_p/75\Omega$	Set the voltage using the following equation. $\text{Volts peak} = \frac{\text{Sweep width (Hz P-P)}}{2} \times \frac{\text{test tone level of test point (V}_{\text{rms}}/75\Omega)}{\text{test tone deviation of test point (Hz rms)}}$
⑤ BB FREQUENCY	It is convenient to confirm the IF band sweep width with markers. Required modulation frequency. For Linearity and Delay measurement, set the BB frequency to less than 1 MHz, for DG and DP measurement, set the BB frequency to more than 1 MHz (≤ 8.2 MHz).
⑥ BB OUTPUT LEVEL dBm	Set level corresponds to FM deviation 200 kHz rms for Linearity and Delay measurement, or FM deviation 500 kHz rms for DG and DP measurement.
⑦ (OUTPUT SELECT)	BB + SWEEP OUTPUT <input checked="" type="checkbox"/>
RECEIVER:	
⑧ RECEIVER MODE	BB.
⑨ RANGE	AUTO.
⑩ FREQ SELECT	MARKER, FREQUENCY : Set the frequency to observing bandwidth.
⑪ X SELECT	IF. (Refer to Note 1).
⑫ X PHASE, BLANKING	Adjusting the knob to coincide the tracing marker pulse with the retracing marker pulse while the BLANKING switch is OFF. After adjusting, set the BLANKING switch to ON.
⑬ Measurements	Push Y1, Y2 measuring keys. Do not select the AMPL and RET. LOSS keys. (If BB SWEEPER option 01 is installed, oscillation of the X axis on the CRT will stop.)

demodulator, and so forth) BB TO BB

Note 1: For end to end measurement, the horizontal-axis signal and frequency marker can be obtained by supplying the signal branched from the IF section of object being measured to the IF INPUT connector. If this branching is difficult, set the X SELECT to BB. However, in this case, the BB INPUT input signal must include the sweep frequency component.

(1) Group Delay Measurement

- (a) Y1 keys DELAY/DP.
- (b) Confirm that modulation frequency is less than 1 MHz and deviation is about 200 kHz rms.
- (c) Scale sensitivity is displayed in ns/DIV.

(2) Linearity Measurement

- (a) Y1 keys LINEARITY/DG.
- (b) Confirm that modulation frequency is less than 1 MHz and deviation is about 200 kHz rms.
- (c) Scale sensitivity is displayed in %/DIV.

(3) Differential Phase Measurement

- (a) Y1 keys DELAY/DP.
- (b) Confirm that modulation frequency is more than 1 MHz (≤ 8.2 MHz), and FM deviation is about 500 kHz rms.

Note 1: To convert to delay time, use the equation below:

$$\tau \text{ (ns)} = \frac{\text{DP (degree)}}{0.36 \times \text{fm (MHz)}}$$

A conversion table for group delay and the differential phase calculated using the above equation is given in Appendix [25].

- (c) Scale sensitivity is displayed in DEG/DIV.

(4) Differential Gain Measurement

- (a) Y1 keys LINEARITY/DG.
- (b) Confirm that modulation frequency is more than 1 MHz (≤ 8.2 MHz), and FM deviation is about 500 kHz rms.
- (c) Scale sensitivity is displayed in %/DIV.

(5) Dual Trace Display

- (a) Key in the two measurement items to be simultaneously measured at Y1 and Y2.
- (b) Dual trace display of measurement items having respective different modulation frequencies, such as delay and DP measurement items for example, is impossible.

Note 2: For dual trace display including measurement of return loss, see Paragraph [15].

MODULATOR SENSITIVITY

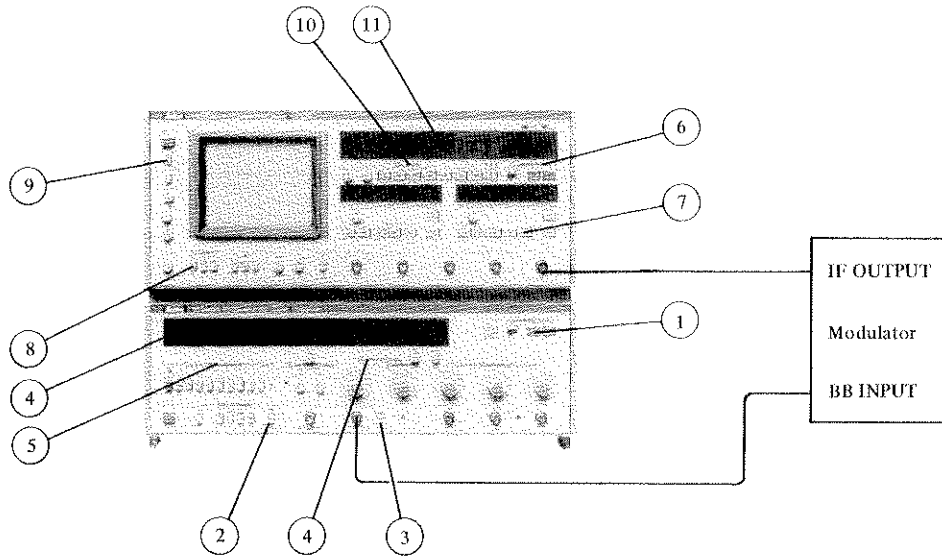

5



Presetting the REAR PANEL
Set the controls as follows:

TRANSMITTER:

- ① TRANSMITTER MODE BB.
- ② LOW BB FREQUENCY OFF
- ③ (OUTPUT SELECT) BB OUTPUT
- ④ BB OUTPUT LEVEL dBm -50 dBm.
- ⑤ BB FREQUENCY Hz K type -- 200 kHz, L type -- 278 kHz, M type -- 250 kHz.

RECEIVER:

- ⑥ RECEIVER MODE
 - IF BAND Required band.
 - BB, IF IF.
- ⑦ Y2 keys SPECTRUM.
- ⑧ X SELECT IF.
- ⑨ BLANKING ON.

Deviation meter calibration

- ④ BB OUTPUT LEVEL dBm Start at -50 dBm and slowly raise the level. Stop when the spectrum image on CRT screen reaches first carrier zero. Refer to the following figure.
- ⑩ CAL Push this key twice.
- ⑪ DEVIATION kHz rms CAL The deviation meter is calibrated with the CAL key ⑪.
K type -- 340 kHz rms, L type -- 472 kHz rms, M type -- 425 kHz rms.

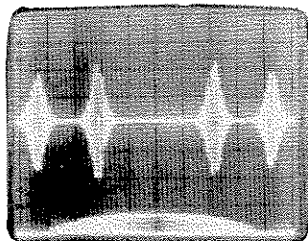

The first carrier zero

Measurement (1): At this time, read the BB OUTPUT LEVEL ④ X dBm and DEVIATION ⑪.

$$\text{Modulator sensitivity} = \frac{\text{DEVIATION (kHz rms)}}{X \text{ (dBm)}}$$

Measurement (2): Set BB OUTPUT LEVEL ④ to test tone level, and read DEVIATION ⑪.

$$\text{Modulator sensitivity} = \frac{\text{DEVIATION (kHz rms)}}{\text{Test tone level (dBm)}}$$

FREQUENCY DEVIATION

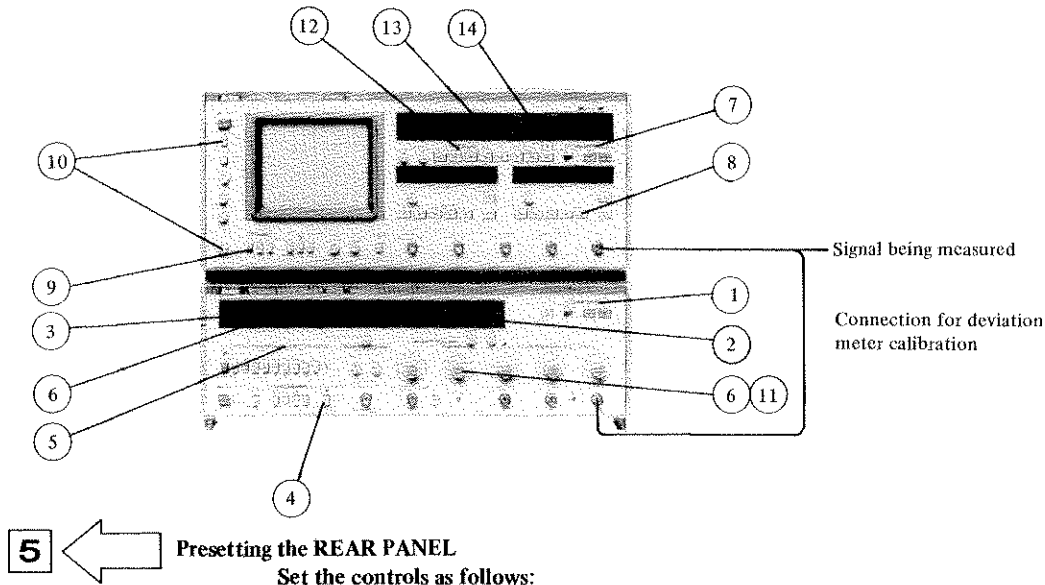

(1) Calibrate the DEVIATION meter. Connect IF OUTPUT to IF INPUT by cable.

TRANSMITTER:

- | | | |
|---|-------------------|---|
| ① | TRANSMITTER MODE | |
| | IF BAND | Required band. |
| | BB, IF | IF. |
| ② | IF CENTER FREQ | 70 MHz or 140 MHz. |
| ③ | SWEEP WIDTH ±MHz | Zero. |
| ④ | LOW BB FREQUENCY | OFF <input type="checkbox"/> |
| ⑤ | BB FREQUENCY | K type – 200 kHz, L type – 278 kHz, M type – 250 kHz. |
| ⑥ | DEVIATION kHz rms | Set the deviation to K type – 340 kHz, L type – 472 kHz rms and M type – 425 kHz rms. |

RECEIVER

- | | | |
|---|-------------------------------|--|
| ⑦ | RECEIVER MODE | |
| | IF BAND | Required band. |
| | BB, IF | IF. |
| ⑧ | Y2 keys | SPECTRUM. |
| ⑨ | X SELECT | IF. |
| ⑩ | BLANKING | ON. |
| ⑪ | DEVIATION dial of TRANSMITTER | Readjust the DEVIATION kHz rms dial of the TRANSMITTER to get the first carrier zero spectrum on the CRT screen. |
| ⑫ | CAL | Push this key twice. |
| ⑬ | DEVIATION kHz rms CAL | The deviation meter is calibrated with the CAL key ⑫. |

(2) Measurement, Input the unknown deviation signal to the IF INPUT terminal.

Deviation is directly displayed on the panel ⑬.

- Note: Measurement accuracy ① When modulation frequencies are 200 kHz, 278 kHz or 250 kHz and BB FREQUENCY Hz LED ⑭ is lit, the error is exceedingly small.
- Measurement accuracy ② When BB FREQUENCY Hz LED ⑭ except 200 kHz, 278 kHz or 250 kHz is lit, the error is less than 10 %.
- Measurement accuracy ③ Pay attention to the accuracy in the deviation measurement of the other modulation frequencies ($80 \text{ kHz} \leq f_m \leq 8.2 \text{ MHz}$) which are not built in this equipment, because error is not so high in this case.

DEMODULATOR SENSITIVITY

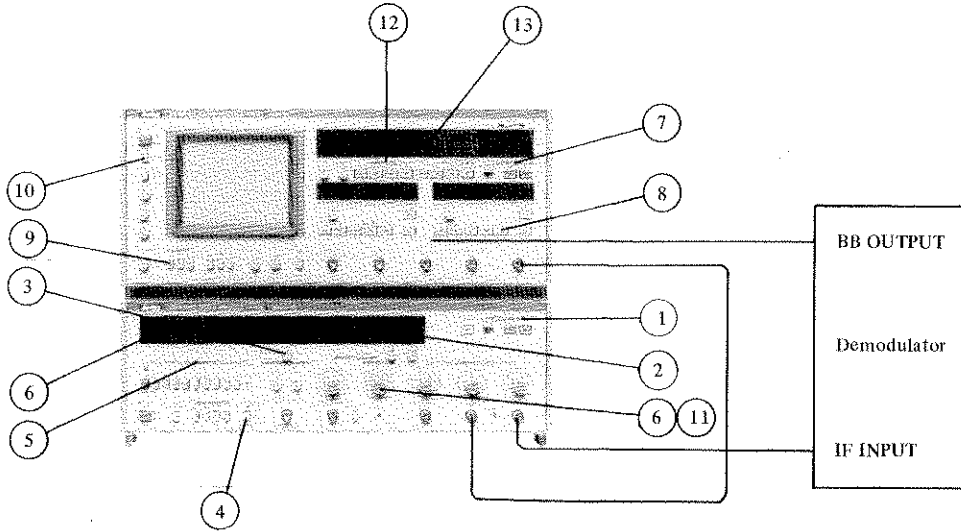

5

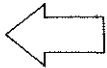

Presetting the REAR PANEL

Set the controls as follows:

(1) Calibrate the DEVIATION of TRANSMITTER as follows.

TRANSMITTER:

- ① TRANSMITTER MODE
IF BAND Required band. (70 MHz or 140 MHz)
BB, IF IF.
- ② IF CENTER FREQ 70 MHz/140 MHz.
- ③ SWEEP WIDTH \pm MHz Zero.
- ④ LOW BB FREQUENCY OFF
- ⑤ BB FREQUENCY K type – 200 kHz, L type – 278 kHz, M type – 250 kHz.
- ⑥ DEVIATION kHz rms Set the deviation to K type – 340 kHz rms, L type – 472 kHz rms and M type – 425 kHz rms.

RECEIVER:

- ⑦ RECEIVER MODE
IF BAND Required band.
BB, IF IF.
- ⑧ Y2 keys SPECTRUM.
- ⑨ X SELECT IF.
- ⑩ BLANKING ON.
- ⑪ DEVIATION dial of TRANSMITTER Readjust the DEVIATION kHz rms dial of the TRANSMITTER to get the first carrier zero spectrum on CRT screen.
- ⑫ CAL Push this key twice.
- ⑬ DEVIATION kHz rms CAL The deviation meter is calibrated with the CAL key ⑫.

(2) Measurement A

- (a) Read DEVIATION ⑬ X Hz rms.
- (b) Push RECEIVER MODE ⑦ BB.
- (c) Read INPUT LEVEL dBm ⑬ Y dBm.
- (d) Calculate the demodulator sensitivity with the following equation.

$$\text{Demodulator Sensitivity} = \frac{\text{BB level Y (dBm)}}{\text{Deviation X (Hz rms)}}$$

(3) Measurement B

- (a) Set the DEVIATION ⑬ to test tone deviation (ex. 140 kHz rms or 200 kHz rms).
- (b) Push RECEIVER MODE ⑦ BB.
- (c) Read INPUT LEVEL dBm ⑬ Y dBm.
- (d) Calculate the demodulator sensitivity with the following equation.

$$\text{Demodulator Sensitivity} = \frac{\text{BB level (dBm)}}{\text{Test tone deviation (Hz rms)}}$$

FREQUENCY ADJUSTMENT

(Center Frequency of Modulator and IF signal)

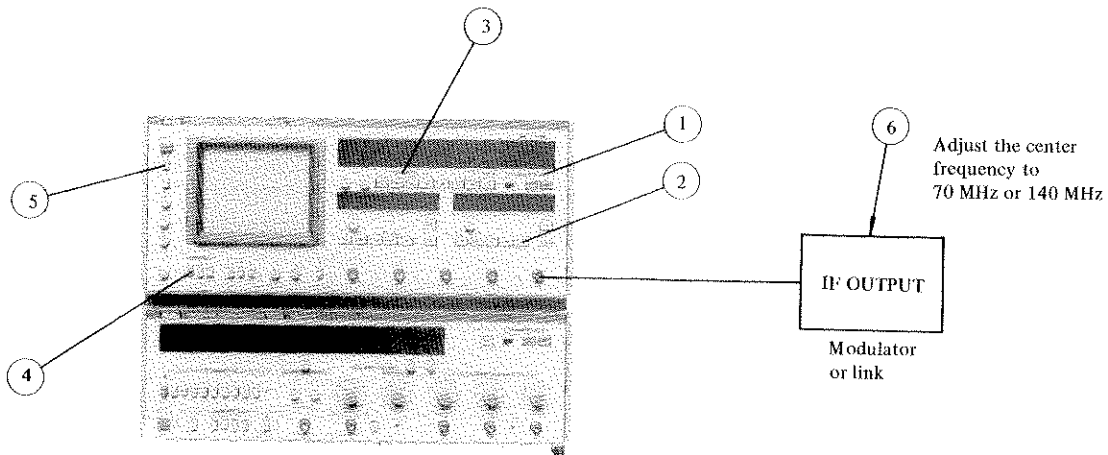

5

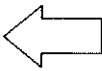

Presetting the REAR PANEL

Set the controls as follows:

RECEIVER:

- | | | | |
|---|---|---------|---------------------------------------|
| ① | RECEIVER MODE | | |
| | | IF BAND | Required band. |
| ② | Y2 keys | | SPECTRUM. |
| ③ | MARKER | | SLIDE. 70 MHz/140 MHz Marker appears. |
| ④ | X SELECT | | IF. |
| ⑤ | BLANKING | | ON. |
| ⑥ | Adjust the Center frequency controller of the object being measured to 70 MHz or 140 MHz, as shown below. | | |

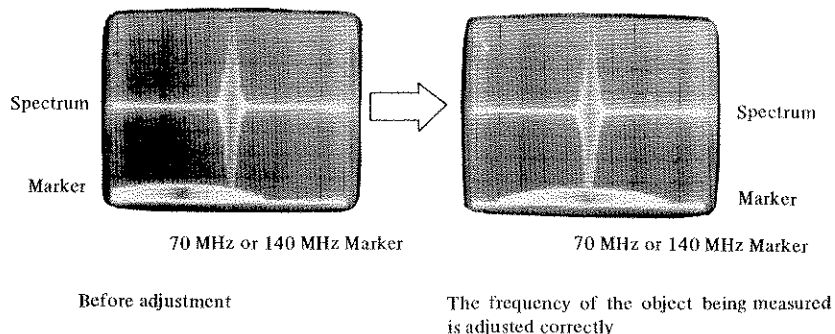

Note 1: When the IF INPUT signal is not 70 ± 0.7 MHz, use the slide marker and read the frequency as follows:

- o Align the positions of the spectrum and the slide marker with the MARKER FREQUENCY controller.
- o Read the slide marker frequency on the LED display at this time.
- o Obtain the input signal frequency from the center marker frequency f_0 (70 MHz or 140 MHz) and the slide marker frequency f_s as follows:

Turn the MARKER FREQUENCY controller counterclockwise:

- (a) If the marker waveform on the CRT moves from left to right: Input frequency = $f_0 - f_s$.
- (b) If the marker waveform on the CRT moves from right to left: Input frequency = $f_0 + f_s$.

Note 2: The usage range is correct if the slide marker frequency shown on the LED display increases when the frequency controller is turned clockwise. If the frequency decreases, continue turning the frequency controller clockwise until zero frequency is passed. This will result in the correct position.

IF RETURN LOSS – CRT sensitivity 1 dB/div

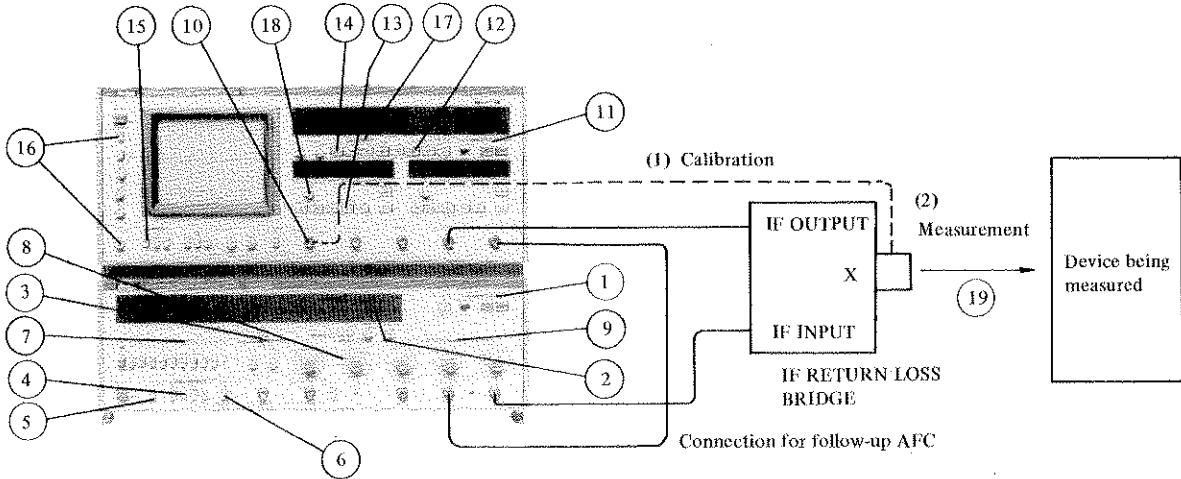

5

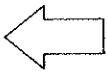

Presetting the REAR PANEL

Set the controls as follows:

(1) Calibration of RETURN Loss indicator.

TRANSMITTER:

- ① TRANSMITTER MODE
IF BAND Required band.
BB, IF IF.
 - ② IF CENTER FREQ 70 MHz or 140 MHz.
 - ③ SWEEP WIDTH Required bandwidth.
 - ④ SWEEP FREQUENCY LINE.
 - ⑤ SWEEP REDUCTION OFF.
 - ⑥ LOW BB FREQUENCY OFF.
 - ⑦ BB FREQUENCY Hz Less than 1 MHz
 - ⑧ DEVIATION kHz rms 200 kHz rms of less
 - ⑨ IF OUTPUT LEVEL dBm +10 dBm.
 - ⑩ Connect the X terminal of the RETURN LOSS BRIDGE to MISSMATCH 20 dB terminal for calibration.
- } These settings are not needed theoretically, but are effective for receiver stability.

RECEIVER:

- ⑪ RECEIVER MODE
IF BAND Required band the same as TRANSMITTER.
BB, IF IF.
- ⑫ RANGE AUTO.
- ⑬ Y1 keys RET LOSS, IF
- ⑭ FREQ SELECT MARKER, FREQUENCY: Set the required band.
- ⑮ X SELECT IF.
- ⑯ X PHASE, BLANKING Adjust the knob to coincide the tracing marker image with the re-tracing marker image while the BLANKING switch is OFF. After adjusting, set the BLANKING switch to ON.
- ⑰ CAL Push this key twice. The calibration factor 20 dB is displayed on Y1 panel display.
- ⑱ POSITION Adjust the 20 dB return loss image on CRT to the center of the Y axis scale as shown below.

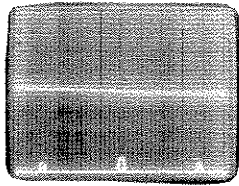

20 dB Return Loss

20 dB

Markers

Calibration of Return Loss image

(2) Measurement

- ⑲ Connect the X terminal of the RETURN LOSS BRIDGE to the device being measured.

IF RETURN LOSS

Measurement Example

RANGE - AUTO

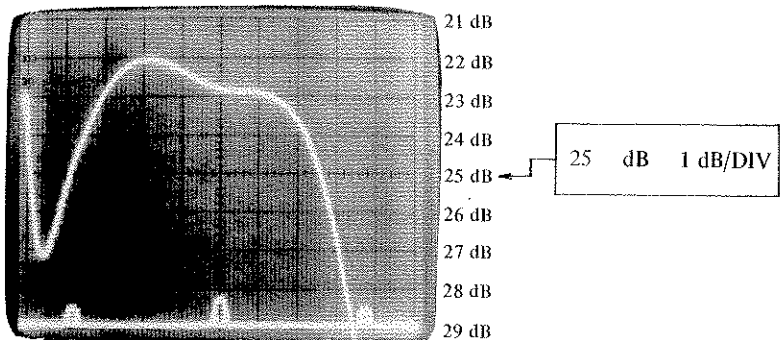

When RANGE (12) is set to AUTO, the center value of the scale is displayed on the Y1 panel display automatically by measuring results.

The marker frequency (14) is set to ± 10 MHz.

Fig. A

RANGE - MANUAL

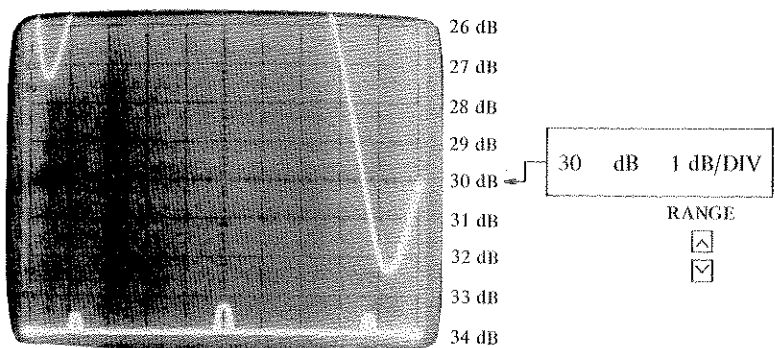

When RANGE (12) is set to MANUAL, the center value of the scale and the displayed center value on the Y1 panel display. Can be changed by the RANGE keys as shown in Fig. B.

Fig. B

Dual Trace Display Included IF Return Loss Characteristic

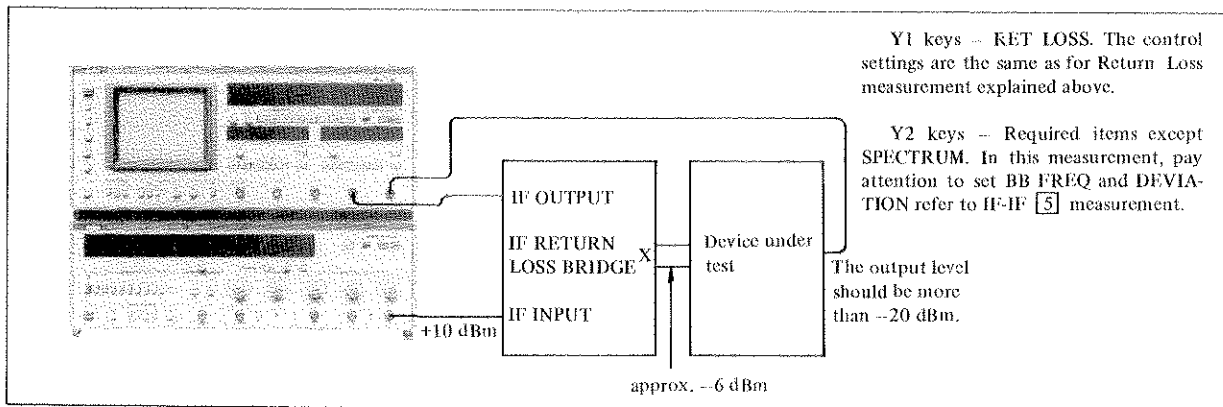

Changing the 20 dB calibration factor

If a standard terminator which has a severe value is prepared for use instead of the built-in 20 dB mismatch, the factor can be changed as follows:

- (i) Connect the X terminal of the IF RETURN LOSS BRIDGE to the standard value terminator.
- (ii) CAL (17) -- Push. The LED is lit.
- (iii) Adjust the numerical value of the Y1 panel display to the standard value using the RANGE keys \uparrow \downarrow .
- (iv) CAL (17) -- Push. The LED is extinguished.
- (v) Measurement -- Connect the X terminal of the IF RETURN LOSS BRIDGE to the device being measured.

IF RETURN LOSS – CRT sensitivity 5 dB/div

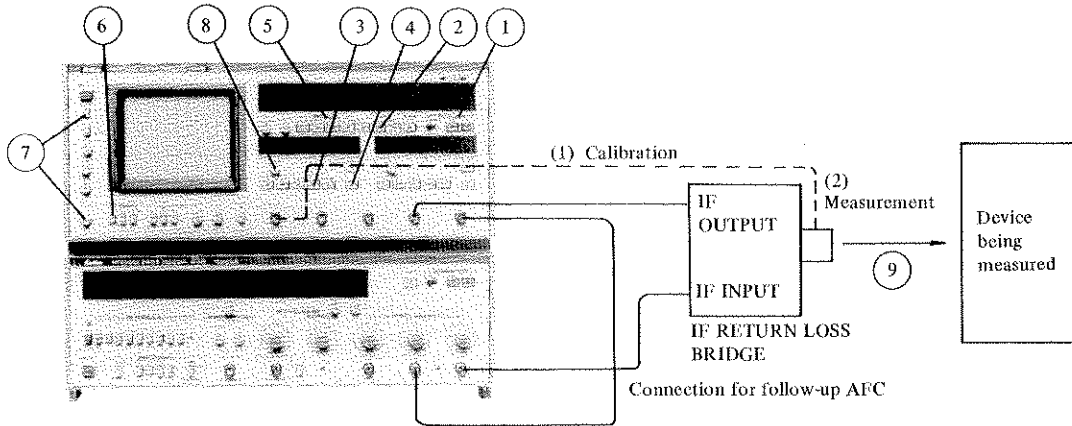

5

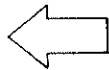

Presetting the REAR PANEL

Set the controls as follows:

- | | |
|---|---|
| (1) Setting of TRANSMITTER: | Same as measurement using CRT 1 dB/div. |
| (2) RECEIVER: | |
| ① RECEIVER MODE | |
| IF BAND | Required band the same as TRANSMITTER. |
| BB, IF | IF |
| ② RANGE | MANUAL |
| ③ Y2 keys | RET LOSS |
| ④ Y1 <input checked="" type="checkbox"/> keys | Pressed repeatedly until Y1 LED display becomes 5 dB/div.
(The step after Return Loss 13 dB is 5 dB/div.)
There are the following two methods of returning to the 1 dB/div range: |
| | Method 1: RANGE ② AUTO |
| | Method 2: Push Y1 <input checked="" type="checkbox"/> keys |
| ⑤ FREQ SELECT | MARKER, FREQUENCY: Set the required band. |
| ⑥ X SELECT | IF. |
| ⑦ X PHASE, BLANKING | Adjust the knob to coincide the tracing marker image with the retracing marker image while the BLANKING switch is OFF. After adjusting, set the BLANKING switch to ON. |
| ⑧ POSITION | Adjust the 20 dB return loss image on CRT to the second line of the Y axis scale as shown below. |
- Calibration of Return Loss image
- (3) Measurement
- ⑨ Connect the X terminal of the RETURN LOSS BRIDGE to the device being measured.

Simultaneous measurement of IF return loss and BB delay (or BB linearity)

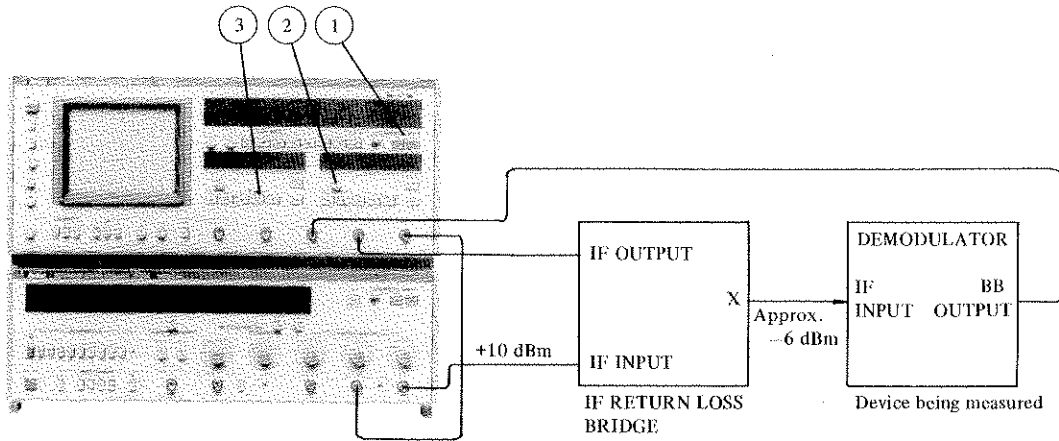

Settings other than the below are the same as for measurement using CRT 1 dB/div, 5 dB/div.

RECEIVER	
① RECEIVER MODE	BB
② Y1 keys	RET. LOSS, IF (When Y1 RET. LOSS is pressed once when RECEIVER MODE ① is BB, RET. LOSS-BB is set. When it is pressed again, RET. LOSS-IF is set.)
③ Y2 keys	Linearity or Delay (Refer to page [9] IF to BB measurement, and set the transmitter BB FREQ, DEVIATION.)

BB RETURN LOSS

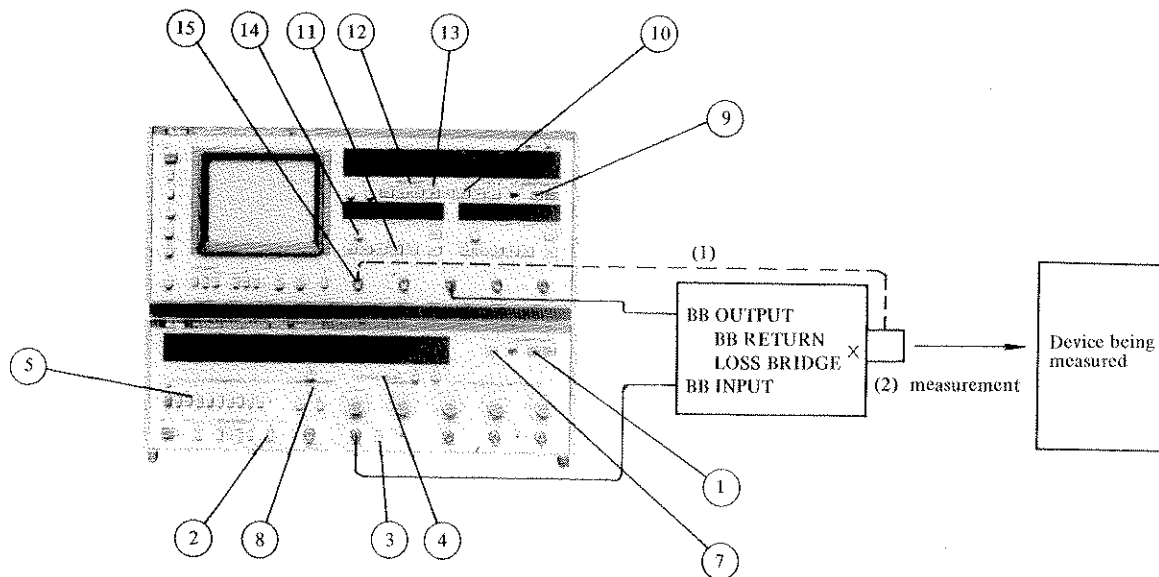

5



Presetting the REAR PANEL
Set the controls as follows:

(1) Point-by-point measurement.

TRANSMITTER:

- ① TRANSMITTER MODE BB.
- ② LOW BB FREQUENCY OFF
- ③ (OUTPUT SELECT) BB OUTPUT
- ④ BB OUTPUT LEVEL dBm +10 dBm.
- ⑤ BB FREQUENCY Desired frequency.

RECEIVER:

- ⑥ RECEIVER MODE BB.

Measurement

- (i) Connect the X terminal of the BB RETURN LOSS BRIDGE to MISMATCH 20 dB ⑦.
- (ii) Read the BB LEVEL dBm X dBm.
- (iii) Connect the X terminal of the BB RETURN LOSS BRIDGE to the device being measured.
- (iv) Read the BB LEVEL dBm Y dBm.
- (v) Calculation

$$\text{Return Loss} = X - Y + 20 \text{ (dB)}$$

(2) Measurement used BB SWEEPER Function (Option).

TRANSMITTER:

- ⑦ BB SWEEPER Push.
- ② LOW BB FREQUENCY OFF
- ③ BB OUTPUT SELECT BB.
- ④ BB OUTPUT LEVEL dBm +5 dBm
- ⑧ BB SWEEPER FREQUENCY After setting the RECEIVER controls, adjust the START, STOP knob while observing the Marker line on the CRT.

RECEIVER:

- ⑨ RECEIVER MODE BB.
- ⑩ RANGE AUTO.
- ⑪ Y1 keys RET LOSS.—BB

BB RETURN LOSS

- (12) MARKER SLIDE or 2 MHz COMB + SLIDE. (Do not use these markers, other markers appear as in the following Fig. A).
- (i) Connect the X terminal of the BB RETURN LOSS BRIDGE to MISMATCH 20 dB terminal (15).
- (13) CAL Push the key twice. Calibration factor 20 dB is displayed on Y2 panel indicator.
- (14) POSITION Shift the 20 dB return loss image on the CRT to the center of the Y axis scale as in the following Fig. A.

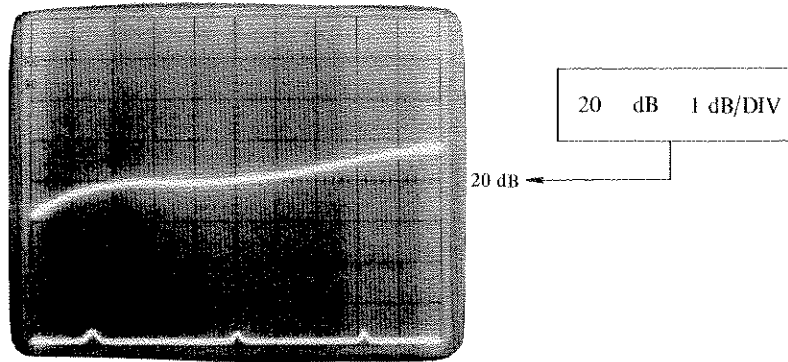
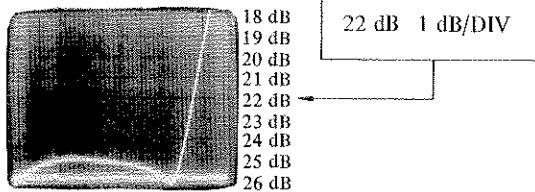

Fig. A

Measurement
Connect the X terminal of BB RETURN LOSS BRIDGE to the device being measured.

Measurement Example

RANGE - AUTO



When RANGE (10) is set to AUTO, the center value of the scale is displayed on Y1 panel automatically by measuring result.

RANGE - MANUAL

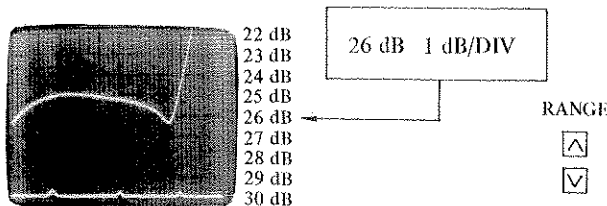

When RANGE (10) is set to MANUAL, the center value of the scale and the displayed center value on the Y1 panel can be changed by the RANGE keys as in Fig. C.

Frequency Markers: Marker frequency is shown as follows.

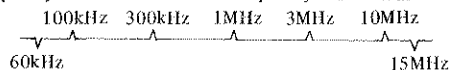

BB TO BB AMPLITUDE RESPONSE (Swept method)

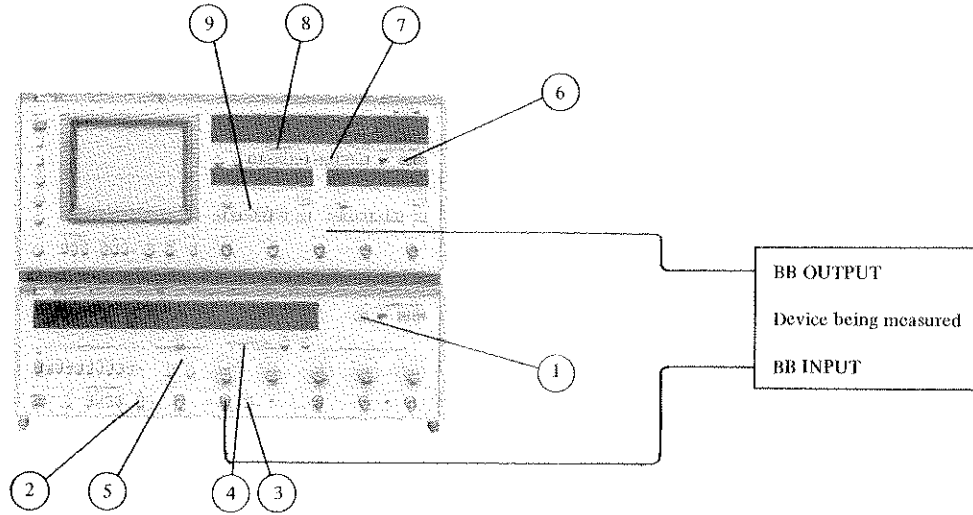

5 **Presetting the REAR PANEL**
Set the controls as follows:

TRANSMITTER:		
①	BB SWEEPER	Push.
②	LOW BB FREQUENCY	OFF <input checked="" type="checkbox"/>
③	(OUTPUT SELECT)	BB OUTPUT <input checked="" type="checkbox"/>
④	BB OUTPUT LEVEL dBm	Required level.
⑤	BB SWEEPER FREQUENCY	Adjust the START, STOP knob while observing the Marker line on the CRT after setting the RECEIVER controls.
RECEIVER:		
⑥	RECEIVER MODE	BB.
⑦	RANGE	AUTO.
⑧	FREQ SELECT	MARKER.
⑨	Y1 or Y2 keys	AMPL.
Measurement.		

Measurement Example

RANGE - AUTO

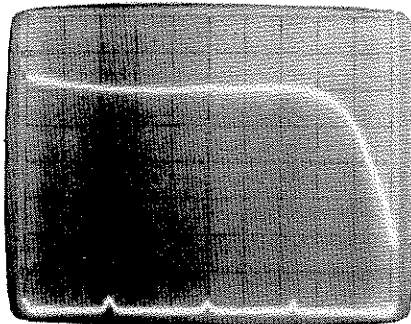

1.0 dB/DIV

RANGE can be set to MANUAL to change the Y axis sensitivity, when the sensitivity is not suitable for measurement.

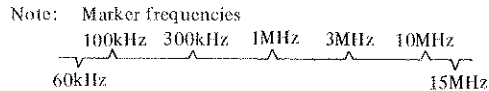

Note: If the amplitude characteristic of the device being measured is larger than about 15 dB, the X axis and the markers cannot be regenerated on the CRT. In this case, the swept band should be narrowed by START and STOP knobs.

DC CHARACTERISTIC (ex. S curve of demodulator)

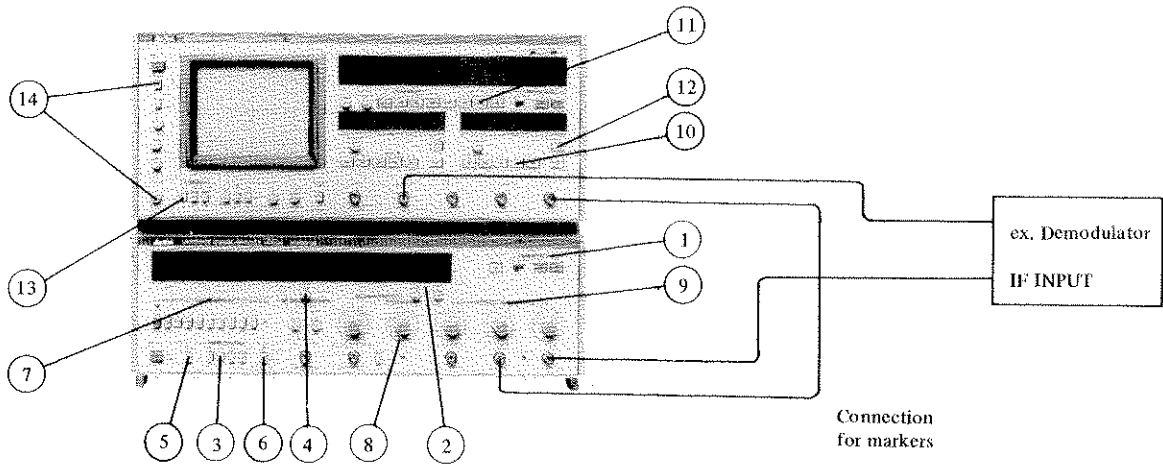

5 ← **Presetting the REAR PANEL**

Set the controls as follows (ex. S curve characteristic of demodulator):

TRANSMITTER:		
①	TRANSMITTER MODE	
	IF BAND	Required band.
	BB, IF	IF.
②	IF CENTER FREQ	70 MHz or 140 MHz.
③	SWEEP FREQUENCY	LINE.
④	SWEEP WIDTH	Required sweep width.
⑤	SWEEP REDUCTION	OFF <input type="checkbox"/>
⑥	LOW BB FREQUENCY	OFF <input type="checkbox"/>
⑦	BB FREQUENCY	Less than 1 MHz
⑧	DEVIATION	200 kHz rms or less
⑨	IF OUTPUT LEVEL dBm	Required level.
RECEIVER:		
⑩	Y2 keys	DC.
⑪	RANGE	MANUAL.
⑫	The sensitivity of the CRT can be changed by these RANGE keys.	
⑬	X SELECT	IF or EXT/LINE.
⑭	X PHASE, BLANKING	Adjust the knob to coincide the tracing image with the re-tracing image while the BLANKING switch is OFF. After adjustment, push the BLANKING switch ON.

Measurement.

These settings are not needed theoretically, but are effective for Receiver stability.

AM-PM CONVERSION COEFFICIENT

— AM METHOD —

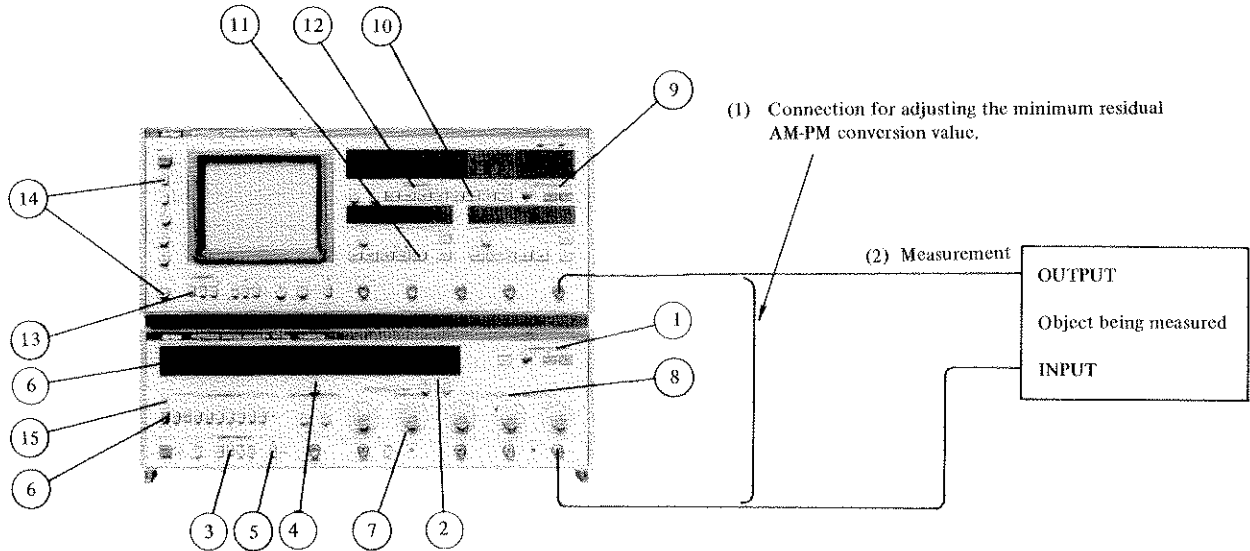

5

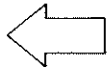

Presetting the REAR PANEL

Set the controls as follows:

- (1) Calibration — Minimize the residual AM-PM conversion value.
Connect IF OUTPUT terminals to IF INPUT terminal directly.

TRANSMITTER:

- | | | |
|-----------------------|-------------------|--|
| ① TRANSMITTER MODE | IF BAND
BB, IF | Required band. (70 MHz or 140 MHz)
IF. |
| ② IF CENTER FREQ | | 70 MHz or 140 MHz. |
| ③ SWEEP FREQUENCY | | LINE. |
| ④ SWEEP WIDTH ±MHz | | Required sweep width. |
| ⑤ LOW BB FREQUENCY | | OFF <input checked="" type="checkbox"/> |
| ⑥ AM-PM | | Push.
(i) IF OUTPUT signal is AM and FM modulated.
(ii) The modulation frequencies are K type — 200 kHz, L type — 278 kHz, M type — 250 kHz.
(iii) The AM modulation frequencies are a little larger (500 Hz) than FM modulation frequencies. |
| ⑦ DEVIATION kHz rms | | Set the DEVIATION display of Receiver to 200 kHz rms (within 190 to 209 kHz) |
| ⑧ IF OUTPUT LEVEL dBm | | Required level (—20 dBm to +10 dBm) |

RECEIVER:

- | | | |
|--------------------|-------------------|---|
| ⑨ RECEIVER MODE | IF BAND
BB, IF | Required band the same as TRANSMITTER.
IF. |
| ⑩ RANGE | | AUTO. |
| ⑪ Y1 keys | | AM-PM. |
| ⑫ FREQ SELECT | | MARKER. |
| ⑬ X SELECT | | IF. |
| ⑭ X PHASE BLANKING | | Adjust the knob to coincide the tracing marker signal with the re-tracing marker signal while the BLANKING switch is OFF. |
| ⑮ AM-PM ADJ | | Minimize the amplitude of the beat wave by adjusting this knob, when the amplitude (peak to peak) is more than 0.3°/dB, as shown in Fig. a. |

(2) Measurement.

Connect IF OUTPUT and IF INPUT to the device being measured.

- | | |
|-----------------------|-----------------|
| ⑧ IF OUTPUT LEVEL dBm | Required level. |
|-----------------------|-----------------|

AM-PM CONVERSION COEFFICIENT

Residual PM.

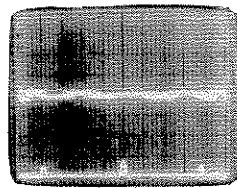

0.2 °/dB /DIV

Note: If the deviation display of the Receiver is out of 190 to 209 kHz rms. AM-PM CONVERSION COEFFICIENT measurement facility does not function.

Fig. a

Measurement example

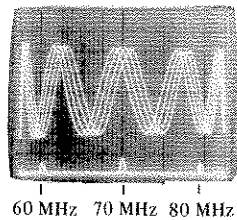

0.2 °/dB /DIV

Fig. b

AM-PM CONVERSION COEFFICIENT — STANDARD GROUP DELAY NETWORK METHOD —

If a Parabolic Delay Network is inserted into the circuit in front of the object being measured as shown in Fig. (1), 1st order slope of differential gain is generated by the 1st order AM-PM conversion coefficient ϕ_1 of the object being measured, and the measured value will vary. Therefore, from the amount of this variation, ϕ_1 can be derived.

$$\phi_1 = \frac{dp_1}{2fd^2 \cdot \pi \cdot \gamma_2} \text{ (radian)}$$

where,

- dp1 = 1st order coefficient of differential gain (1/Hz)
- fd = differential frequency (Hz)
- γ_2 = parabolic group delay coefficient (sec/Hz²)



Figure (1) AM-PM Conversion Coefficient Measurement According to Standard Group-Delay Network Method

However, the Parabolic Delay Network also has differential gain characteristics, as shown in Fig. (2) (a), so it is necessary to be careful when reading the 1st order slope from the differential gain component.



- a) Differential gain characteristics of Parabolic Delay Network
- b) Differential gain characteristics from ϕ_1 .
- c) Differential gain characteristics component added to differential gain characteristics of the object to be measured.

Fig. (2) Differential Gain Measurement Image

MEASUREMENT FOR COMMUNICATIONS SATELLITES

IMPROVEMENT OF THRESHOLD LEVEL**(For the signal of small C/N ratio)**

When the THRESHOLD EXTENSION switch on rear panel of the receiver is ON, a narrow bandpass filter is inserted into the circuit and the threshold is improved (equivalent C/KT: 73 dB at noise band less than 30 MHz). But in this case the BB frequency must be 556 kHz or less.

S/N IMPROVEMENT ON CRT

The receiving signal through satellite Links include large amount of noise. Therefore the measuring result on the CRT has too much noise.

In this case, the NORMLZR (Normalizer) function of the RECEIVER is effective for noise reduction on the CRT by employing signal averaging techniques.

Details on NORMLZR functions are explained on page [4](#).

LIMITATION OF MODULATING BB FREQUENCY AND FM DEVIATION

When measure a narrow bandpass filter for example, 2.5 MHz, it is necessary to conduct the measurement with the BB frequency at 100 kHz or less, and the frequency deviation as low as possible (for example, 50 to 100 kHz rms).

STABLE OPERATION OF CRT HORIZONTAL AXIS

When the SWEEP OUTPUT terminal on the rear panel of the transmitter is connected to the EXT/LINE SELECT-EXT terminal on the rear panel of the receiver, the horizontal axis will operate stably even if the IF sweep width is narrow.

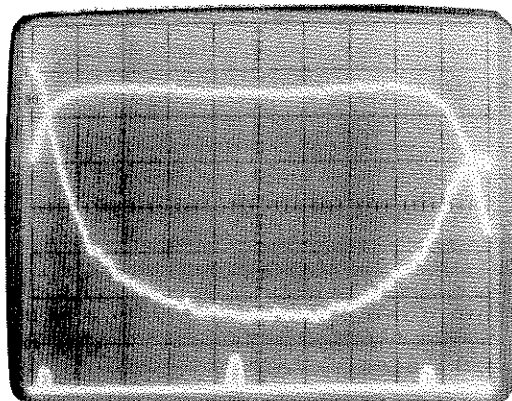
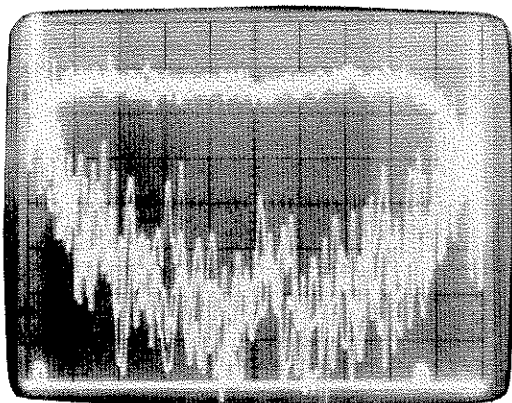

LOW BB (55.6 kHz or 27.8 kHz) MEASUREMENT

The group delay measurement in a narrow-band (BW 1.25 MHz/70 MHz, BW 2.5 MHz/70 MHz) is necessary for FDMA satellite communication system.

The low BB frequency with sufficient frequency resolution is necessary for measuring such a narrow-band characteristic.

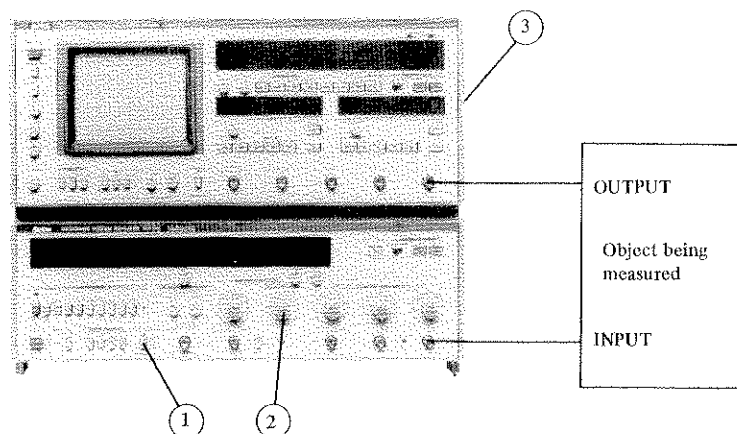

Rear panel presetting and settings other than the following are the same as for measurements using other BB frequencies. (See [7] to [10].)

(1) TRANSMITTER

- ① LOW BB FREQUENCY ON
- ② DEVIATION kHz rms Approx. 50 kHz rms

(2) RECEIVER

- ③ BB SELECT (rear panel) 55.6 kHz (or 27.8 kHz)
Displayed by lighting of Narrow of BB frequency display and blinking of 55.6 kHz (or 27.8 kHz).
- ④ Measurement Push the Y1, Y2 measuring items keys.

Note: After operations ① to ③ above complete, connect the RECEIVER IF INPUT and the object being measured.

REMOTE MONITORING

Remote monitoring is used to transfer the value measured at a receiving station MSA2 (Microwave System Analyzer 2) to the receiver at the transmitting station MSA1 (Microwave System Analyzer 1).

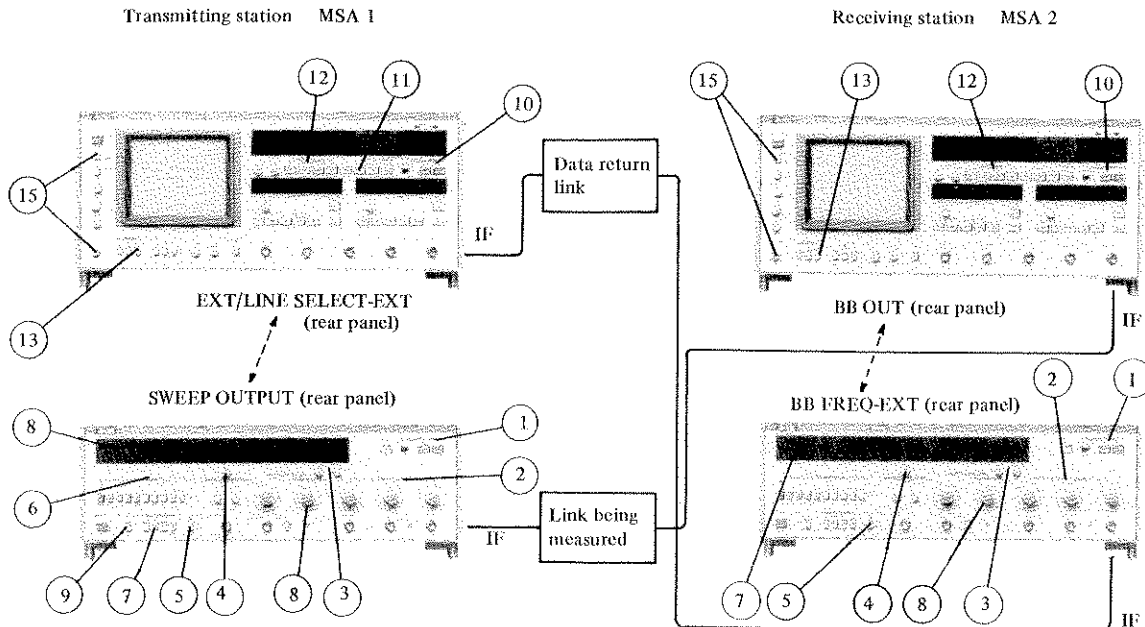

Set the MSA1 and MSA2 controls as follows:

Controls	MSA1	MSA2
Rear Panel (Refer to page 5).		
PLL CUT FREQ	HIGH.	HIGH.
CRT TRACE	CHOP.	CHOP.
THRESHOLD EXTENSION	OFF.	OFF.
MARKER SELECT	INT, SLIDE	INT, SLIDE
CHARACTER	ON	ON
BB SELECT	NORMAL	NORMAL
Connection	Connect SWEEP OUTPUT of transmitter to EXT/LINE SELECT-EXT of Receiver.	Connect BB OUTPUT of Receiver to BB FREQ SELECT-EXT of Transmitter.
Front Panel		
TRANSMITTER		
① TRANSMITTER MODE		
IF BAND	Required band.	Required band.
BB, IF	IF.	IF.
② IF OUTPUT LEVEL dBm	Required level.	Required level.
③ IF CENTER FREQ	70 MHz or 140 MHz.	70 MHz or 140 MHz.
④ SWEEP WIDTH	Required sweep width.	Zero.
⑤ LOW BB FREQUENCY	OFF <input checked="" type="checkbox"/>	OFF <input checked="" type="checkbox"/>
⑥ BB FREQUENCY	Required frequency.	-
⑦ SWEEP FREQUENCY	Line or others.	-
⑧ DEVIATION kHz rms	200 kHz rms (BB frequency <1 MHz) or 500 kHz rms (BB frequency >1 MHz)	200 kHz rms (BB frequency <1 MHz) or 500 kHz rms (BB frequency >1 MHz)
⑨ SWEEP REDUCTION	If required, set to ON.	-

REMOTE MONITORING

Controls	MSA1	MSA2
Front Panel RECEIVER ⑩ RECEIVER MODE IF BAND BB, IF ⑪ RANGE ⑫ FREQ SELECT ⑬ X SELECT ⑭ Y1 or Y2 selectors ⑮ X PHASE BLANKING Measurement	Required band. IF. AUTO. COUNTER. EXT/LINE. Required item as follows. Coincide the trace and re-trace images with BLANKING OFF.	Required band. IF. AUTO. COUNTER. IF. Required item as follows. Coincide the trace and re-trace image with BLANKING OFF. <div style="position: absolute; left: 100px; top: 50px; font-size: 2em;">}</div> These settings are not necessary for data return.

(1) Group Delay Measurement

- (a) Y1 keys DELAY/DP.
- (b) Confirm that modulation frequency is less than 1 MHz and deviation is about 200 kHz rms.
- (c) Scale sensitivity is displayed in ns/DIV.

(2) Differential Phase Measurement

- (a) Y1 keys DELAY/DP.
- (b) Confirm that modulation frequency is more than 1 MHz (≤ 8.2 MHz), and FM deviation is about 500 kHz rms.

Note: To convert to delay time, use the equation below:

$$\tau \text{ (ns)} = \frac{\text{DP (degree)}}{0.36 \times f_m \text{ (MHz)}}$$

A conversion table for group delay and the differential phase calculated using the above equation is given in Appendix

- (c) Scale sensitivity is displayed in DEG/DIV.

(3) Differential Gain Measurement

- (a) Y1 keys LINEARITY/DG.
- (b) Confirm that modulation frequency is more than 1 MHz (≤ 8.2 MHz), and FM deviation is about 500 kHz rms.
- (c) Scale sensitivity is displayed in %/DIV.

(4) Dual Trace Display

- (a) Key in the two measurement items to be simultaneously measured at Y1 and Y2.
- (b) Dual trace display of measurement items having respective different modulation frequencies, such as delay and DP measurement items for example, is impossible.

Note: The remote monitoring function is applicable only to group delay, differential gain and differential phase measurements because the receiving BB signal is returned to the transmitting station with a no-sweep carrier.

SPECIFICATIONS

Measurements

Items		Models	ME538K/L/M	
			70 MHz Band	70 MHz Band
Amplitude (IF INPUT terminal)	Inherent Slope	± 0.05 dB/ ± 25 MHz	± 0.05 dB/ ± 25 MHz	± 0.05 dB/ ± 25 MHz, ± 0.1 dB/ ± 40 MHz, ± 0.2 dB/ ± 50 MHz
	Measuring Range	0 to 16 dB		
	Max Sensitivity	0.01 dB/DIV (at Y2 Display)		
	IF INPUT Level	+10 to -20 dBm		
Amplitude (RET. LOSS INPUT terminal)	Inherent Slope	± 1 dB		
	Measuring Range	0 to 8 dB		
	Sensitivity	1 dB/DIV, 5 dB/DIV		
	INPUT Level	-60 to -20 dBm		
Group Delay	Inherent Slope	0.3 ns/ ± 15 MHz, 0.5 ns/ ± 25 MHz	0.3 ns/ ± 15 MHz, 0.5 ns/ ± 25 MHz	0.3 ns/ ± 20 MHz, 0.5 ns/ ± 30 MHz, 1 ns/ ± 50 MHz
	Measuring Range	0 to 400 ns		
	Max Sensitivity	0.1 ns/DIV (at Y2 Display)		
	Noise	0.05 ns/Condition; $f_M = 200$ kHz \sim 278 kHz, Deviation 200 kHz rms, Using Average function.		
Linearity	Inherent Slope	0.2%/ ± 25 MHz	0.2 %/ ± 25 MHz	0.2 %/ ± 50 MHz
	Measuring Range	0 to 80 %		
	Max Sensitivity	0.05 %/DIV		
	Noise	0.01 %/Condition, $f_M < 1$ MHz, Deviation 200 kHz rms, Using Average function.		
Differential Phase	Inherent Slope*1	0.3°/ ± 15 MHz, 0.5°/ ± 25 MHz	0.3°/ ± 15 MHz, 0.5°/ ± 25 MHz	0.3°/ ± 20 MHz, 0.5°/ ± 30 MHz, 0.8°/ ± 50 MHz
	Measuring Range	0 to 40°		
	Max Sensitivity	0.2°/DIV		
	Noise	0.02°/Condition, $f_M = 5.6$ MHz, Deviation 500 kHz rms, Using Average function.		
		*1: Specified frequency range = Carrier sweep width + 2 f_M		
Differential Gain	Inherent Slope*2	0.2 %/ ± 15 MHz, 0.4 %/ ± 25 MHz	0.2 %/ ± 15 MHz, 0.4 %/ ± 25 MHz	0.3 %/ ± 20 MHz, 0.4 %/ ± 30 MHz, 0.6 %/ ± 50 MHz
	Measuring Range	0 to 80 %		
	Max Sensitivity	0.05 %/DIV		
	Noise	0.01 %/Condition, $f_M = 5.6$ MHz, Deviation 500 kHz rms, Using Average function		
		*2: Specified frequency range = Carrier sweep width + 2 f_M		
IF Return Loss	Frequency Range	70 ± 25 MHz	70 ± 25 MHz	140 ± 50 MHz
	Measuring Range	10 to 50 dB accuracy depends on using bridge.		
	Sensitivity	1 dB/DIV, 5 dB/DIV		
AM to PM Conversion	Residual PM	0.3°/dB/ ± 25 MHz	0.3°/dB/ ± 25 MHz	0.3°/dB/ ± 35 MHz
	Measuring Range	0.3°/dB to 16°/dB		
Spectrum	Center Frequency	70 ± 20 MHz Auto tuning	70 ± 20 MHz Auto tuning	140 ± 30 MHz Auto tuning
	Sweep Width	Approx. ± 700 kHz		
	Max Sensitivity	Detects 0.1 dB change of modulating signal at carrier zero point.		
	Deviation	K type - 340 kHz rms at 200 kHz, L type - 472 kHz rms at 277.778 kHz, M type - 425 kHz rms at 250 kHz.		

SPECIFICATIONS

Deviation	Measuring Range	20 kHz to 999 kHz rms at built-in BB frequencies \leq 8.2 MHz.														
	Accuracy	10 % at built-in BB frequency \leq 8.2 MHz.														
	Calibration	Deviation meter is calibrated by easy key operation. Accuracy reaches 1 % theoretically at specified modulation frequency. Deviation is as shown in the following table by Bessel zero method. <table border="1" style="margin-left: 20px;"> <tr> <th>Model</th> <th>Modulation freq.</th> <th>Key in factor</th> </tr> <tr> <td>K type</td> <td>200 kHz</td> <td>340 kHz rms</td> </tr> <tr> <td>L type</td> <td>277.778 kHz</td> <td>472 kHz rms</td> </tr> <tr> <td>M type</td> <td>250 kHz</td> <td>425 kHz rms</td> </tr> </table>				Model	Modulation freq.	Key in factor	K type	200 kHz	340 kHz rms	L type	277.778 kHz	472 kHz rms	M type	250 kHz
Model	Modulation freq.	Key in factor														
K type	200 kHz	340 kHz rms														
L type	277.778 kHz	472 kHz rms														
M type	250 kHz	425 kHz rms														
Modulator Sensitivity	Mod Signal Level	-50 to +10 dBm														
	Deviation	Use the DEVIATION meter function or use the carrier zero deviation with the SPECTRUM function.														
De-modulator Sensitivity	IF Signal	Calibrate the deviation with DEVIATION meter function or SPECTRUM function.														
	Demo BB Level	-50 to +10 dBm														
Inherent Noise (IF to IF) (For all models)	Group Delay	Linearity	Differential Phase	Differential Gain	Detection Band: 3 kHz											
	66 kHz to 93 kHz: 0.3 ns rms 200 kHz to 278 kHz: 0.1 ns rms 400 kHz to 556 kHz: 0.05 ns rms	0.02% rms	0.05 ° rms	0.1% rms												
	Deviation: 200 kHz rms, $f_M < 1$ MHz			Deviation: 500 kHz rms, $f_M = 5.6$ MHz												

BB (Baseband) measurement

BB to BB Measurements (For all models)	Item	Inherent slope	Measuring range	Max. sensitivity	Noise
	Group Delay	0.1 ns	0 to 400 ns	0.1 ns/DIV (at Y2)	0.2 ns
	Linearity	0.1 %	0 to 80 %	0.05 % DIV	0.05 %
	Differential Phase	0.1 °	0 to 40 °	0.2 °/DIV	0.05 °
	Differential Gain	0.1 %	0 to 80 %	0.05 %/DIV	0.05 %
	Measuring Condition	BB level: -30 dBm			
BB Return Loss	Frequency	Built-in BB frequency or BB amplitude option			
	Range	10 to 40 dB, 1 dB/DIV (BB amplitude option)			
BB Amplitude (Option)	Frequency range: 60 kHz to 15 MHz, Level: +10 dBm to -50 dBm, Inherent slope: Inherent slope: ± 0.5 dB/100 kHz to 13 MHz Measuring range: 0 to 8 dB, Max. sensitivity: 0.1 dB/DIV				
DC Input	Measuring range: 0 to ± 400 mV, Max. sensitivity: 1 mV/DIV				

Receiver

IF Input	<p>Frequency Range (AFC capture and hold range)</p> <p>Level Range</p> <p>Level Display</p> <p>Level Accuracy</p> <p>Impedance</p> <p>Input Frequency Sweep Width</p> <p>Maximum Sweep Width</p> <p>Minimum Sweep Width</p> <p>Demodulation</p>	<p>70 MHz band: 45 to 95 MHz 140 MHz band: 90 to 190 MHz When BB frequency is 55.6 kHz (or 27.8 kHz). *1 70 MHz band: 60 to 80 MHz 140 MHz band: 130 to 150 MHz</p> <p>+10 to -20 dBm</p> <p>3-digit LED display Resolution: 0.1 dB</p> <p>±0.3 dB at +4 dBm</p> <p>75 Ω Return Loss: >30 dB at +4 dBm</p> <p>±25 MHz/center frequency 70 MHz ±50 MHz/center frequency 140 MHz When BB frequency is 55.6 kHz (or 27.8 kHz). ±10 MHz/center frequency 70/140 MHz.</p> <p>The minimum sweep width required for reproducing the HOR signal on the CRT ±0.2 MHz</p> <p>66.6 kHz, 80 kHz to 8.2 MHz *1 BB frequency 55.6 kHz (or 27.8 kHz) is demodulated when sweep frequency is only 18 Hz.</p>
IF Return Loss Input	<p>The return loss input is used with the same frequency applied to IF INPUT to lock the AFC loop.</p> <p>Input Level Range</p> <p>Flatness</p> <p>Impedance</p>	<p>—20 to -60 dBm</p> <p>±1 dB/45 to 95 MHz ±1 dB/90 to 140 MHz</p> <p>75 Ω Return Loss: >28 dB</p>
BB Input (BB + Sweep)	<p>BB Frequency Range</p> <p>BB Level Range</p> <p>BB Level Display</p> <p>BB Level Accuracy</p> <p>Impedance</p> <p>Sweep Frequency Range</p> <p>Sweep Voltage Range</p> <p>X Phase Setting Range</p>	<p>66 kHz to 15 MHz</p> <p>+10 to -50 dBm</p> <p>3-digit LED display Resolution: 0.1 dB</p> <p>±0.3 dB at 0 dBm</p> <p>75 Ω Return Loss: >28 dB at 0 dBm/frequency 66 kHz to 15 MHz</p> <p>18 to 100 Hz</p> <p>±50 mV to ±5 V</p> <p>0 to 360 °</p>

*1 Optional

Phase Detector	Input Frequency	The BB frequency is selected automatically.		
		K type	L type	M type
	f1	66.667 kHz	92.593 kHz	83.333 kHz
	f2	200 kHz	277.778 kHz	250 kHz
	f3	400 kHz	555.556 kHz	500 kHz
	f4	2 MHz	2.4 MHz	
	f5	3.58 MHz		
	f6	4.43 MHz		
	f7	5.6 MHz		
	f8	8.2 MHz		
	f9	12.39 MHz (ME538K/L/M)		
	f10	55.556 kHz ¹ (option)		
	Capture Range	$\pm 5 \text{ Hz} \leq 555.556 \text{ kHz}$ $5 \times 10^{-6} \leq 12.39 \text{ MHz}$ $*1 \pm 1 \text{ Hz} \leq 55.556 \text{ kHz}$		
Frequency Markers	Slide Marker	Variable side markers: 70 \pm 25 MHz, 140 \pm 50 MHz		
	Frequency Display	4-digit LED display Resolution: 10 kHz		
	Accuracy	$\pm 1 \times 10^{-4} \pm 1$ digit		
	2 MHz Comb + Slide	2 MHz Comb Markers + Variable side markers		
Center Frequency Counter	Counts the center frequency of the swept IF signal and displays it on the 5-digit LED display. The display to the LED display is made by selecting either the slide marker frequency or center frequency with a key.			
	Frequency Range	70 MHz band: 45 to 90 MHz 140 MHz band: 90 to 190 MHz		
	Frequency Display	4-digit LED display (ME453K/L/M) 5-digit LED display (ME538K/L/M) Resolution: 10 kHz		
	Accuracy	$\pm 1 \times 10^{-3} \pm 1$ digit		
IF Sweep Width Measurement	Measuring Range	70 MHz band: ± 0.2 to ± 25 MHz 140 MHz band: ± 0.2 to ± 50 MHz		
	Resolution	0.2 to 9.99 MHz: 10 kHz 10 to 50 MHz: 100 kHz		
	Accuracy	$\pm 5 \times 10^{-2} \pm 1$ digit		
BB Output (Rear Panel)	Level	-7 dBm, typical		
	Impedance	75 Ω , nominal		
Ext. Sweep Input (Rear Panel)	Frequency	18 Hz to 100 Hz		
	Level	1 Vp-p		
	Impedance	$> 5 \text{ k}\Omega$, nominal		
X-Y Recorder Output (Option)	Output	X: 0 to 4 V Y: 0 to 4 V Pen lift: Open Pen down: Ground		
	Sweep Speed	20 sec., 40 sec., nominal		

¹ Optional

Transmitter

IF Output	Frequency Range	70 MHz band: 45 to 95 MHz 140 MHz band: 90 to 190 MHz																																												
	Center Frequency Display	4-digit LED display (ME453K/L/M) 5-digit LED display (ME538K/L/M) Resolution: 10 kHz																																												
	Accuracy	$\pm 1 \times 10^{-4} = \pm 1$ digit/CW																																												
	Stability	± 100 kHz at 70 MHz ± 200 kHz at 140 MHz 5 hrs after 1/2 hr warm-up																																												
	Level Range	+10 to -70 dBm (1 dB step attenuator) Continuously variable range: $> \pm 1$ dB																																												
	Level Accuracy	± 0.3 dB at +4 dBm																																												
	Harmonics	< -30 dB																																												
	Impedance	75 Ω Return Loss: > 30 dB at +4 dBm																																												
IF Sweep Width	Sweep Width Range	70 MHz band: 0 to ± 25 MHz 140 MHz band: 0 to ± 50 MHz																																												
	Sweep Width Display	3-digit LED display Resolution: 0.1 MHz																																												
	Auto Sweep Reduction	The sweep width is reduced by 2 x BB frequency $\pm 10\%$ when BB frequency > 1 MHz. This function can be reset with a switch.																																												
FM Deviation	Mod frequency	Same as BB frequency (item 6)																																												
	Deviation Range	5 to 1000 kHz rms																																												
	Deviation Display	4-digit LED display Resolution: 1 kHz rms																																												
AUX IF Output	Frequency Range	Same as IF OUTPUT specifications (item 1).																																												
	Output Level	-10 dBm																																												
	Level Accuracy	$< \pm 1$ dB																																												
	Impedance	75 Ω , nominal																																												
Crystal Output	Frequency	70 MHz band: 70 MHz 140 MHz band: 140 MHz																																												
	Output Level	+5 dBm																																												
	Level Accuracy	$< \pm 1$ dB																																												
	Impedance	75 Ω , nominal																																												
BB + Sweep Output	BB Frequency	<table border="1"> <thead> <tr> <th></th> <th>K type</th> <th>L type</th> <th>M type</th> </tr> </thead> <tbody> <tr> <td>f1</td> <td>66.667 kHz</td> <td>92.538 kHz</td> <td>83.333 kHz</td> </tr> <tr> <td>f2</td> <td>200 kHz</td> <td>277.778 kHz</td> <td>250 kHz</td> </tr> <tr> <td>f3</td> <td>400 kHz</td> <td>555.556 kHz</td> <td>500 kHz</td> </tr> <tr> <td>f4</td> <td>2 MHz</td> <td colspan="2">2.4 MHz</td> </tr> <tr> <td>f5</td> <td colspan="3">3.58 MHz</td> </tr> <tr> <td>f6</td> <td colspan="3">4.43 MHz</td> </tr> <tr> <td>f7</td> <td colspan="3">5.6 MHz</td> </tr> <tr> <td>f8</td> <td colspan="3">8.2 MHz</td> </tr> <tr> <td>f9</td> <td colspan="3">12.39 MHz (ME538K/L/M)</td> </tr> <tr> <td>f10</td> <td colspan="3">55.556 kHz¹ (option)</td> </tr> </tbody> </table>		K type	L type	M type	f1	66.667 kHz	92.538 kHz	83.333 kHz	f2	200 kHz	277.778 kHz	250 kHz	f3	400 kHz	555.556 kHz	500 kHz	f4	2 MHz	2.4 MHz		f5	3.58 MHz			f6	4.43 MHz			f7	5.6 MHz			f8	8.2 MHz			f9	12.39 MHz (ME538K/L/M)			f10	55.556 kHz ¹ (option)		
		K type	L type	M type																																										
f1	66.667 kHz	92.538 kHz	83.333 kHz																																											
f2	200 kHz	277.778 kHz	250 kHz																																											
f3	400 kHz	555.556 kHz	500 kHz																																											
f4	2 MHz	2.4 MHz																																												
f5	3.58 MHz																																													
f6	4.43 MHz																																													
f7	5.6 MHz																																													
f8	8.2 MHz																																													
f9	12.39 MHz (ME538K/L/M)																																													
f10	55.556 kHz ¹ (option)																																													
	<p>¹ Can be changed to 27.778 kHz if so specified. Sweep frequency is automatically set to 18 Hz when f10 is selected.</p> <p>BB Frequency ± 5 Hz ≤ 555.556 kHz Accuracy $\pm 5 \times 10^{-6} \leq 12.39$ MHz ± 1 Hz ≤ 55.5556 kHz *1</p>																																													

(Cont'd) BB + Sweep Output	BB Level	+10 to -50 dBm A 10 dB step attenuator and 0 to -10 dB continuously variable dial are provided for setting the level.
	BB Level Display	3-digit LED display Resolution: 0.1 dB
	BB Level Accuracy	± 0.3 dB at 0 dBm
	BB Harmonics	< -38 dB
	BB Impedance	75 Ω Return Loss: > 28 dB at -10 dBm
	Sweep Frequency	Line (50/60 Hz), 70 Hz Option (select one frequency from 18 Hz to 100 Hz) Ext. (18 Hz to 100 Hz)
	Sweep Level	0 to 6.5 V _{p-p} /75 Ω
	Sweep Level Display	3-digit LED display Resolution: 0.01 V
	Sweep Level Accuracy	± 10 % at 6 V _{p-p}
	Sweep Harmonics	< -35 dB
Sweep Impedance	75 Ω , nominal	
Sweep Output	Sweep Level	0 to 25 V _{p-p} /10 k Ω
	Sweep Level Display	3-digit LED display Resolution: 0.01 x 4 V
	Sweep Level A Accuracy	± 10 % at 24 V _{p-p}
Ext. Sweep Input (Rear panel)	Frequency	18 to 100 Hz
	Level	2 V _{p-p}
	Impedance	75 Ω , nominal
BB Sweeper (Option)	Frequency Range	60 kHz to 15 MHz
	BB Output Level	+10 dBm to -50 dBm (10 dB step attenuator) Continuously variable range: 0 to -10 dB
	BB Level Display	3-digit LED display Resolution: 0.1 dB
	Inherent slope	± 0.5 dB/100 kHz to 13 MHz The value of the sum of the receiver and transmitter.
	Impedance	75 Ω Return Loss: > 28 dB at -10 dBm

Low BB frequency (55.6 kHz or 27.8 kHz) specification (Option)

Group Delay	Inherent Slope	70 ±10 MHz: 5 ns 140 ±10 MHz: 5 ns
	Measuring Range	0 to 400 ns
	Max. Sensitivity	2 ns/div.
	Noise	1 ns, *1
Linearity	Inherent Slope	70 ±10 MHz: 0.5 % 140 ±10 MHz: 0.5 %
	Measuring Range	0 to 80 %
	Max. Sensitivity	0.1 % div.
	Noise	0.1 %*

* With deviation 100 kHz rms using average function.

General Specifications

Input and Output Connector	BNC or SP connector Other type of connector can be installed if requested by the user: e.g., WECO560A or equivalent
Power Supply	260 VA Transmitter: 85 VA Receiver: 175 VA Voltages are available from 100 V AC to 254 V AC, at the request of the user. Tolerance ±10 %
Ambient temperature (Rated range of use)	0° to 50°C
Dimensions and Weight	Receiver: 177H x 426W x 450D(mm), ≤18.5 kg Transmitter: 133H x 426W x 450D(mm), ≤13.5 kg

CHART OF GROUP-DELAY MEASURING ERROR DUE TO AM-PM CONVERSION

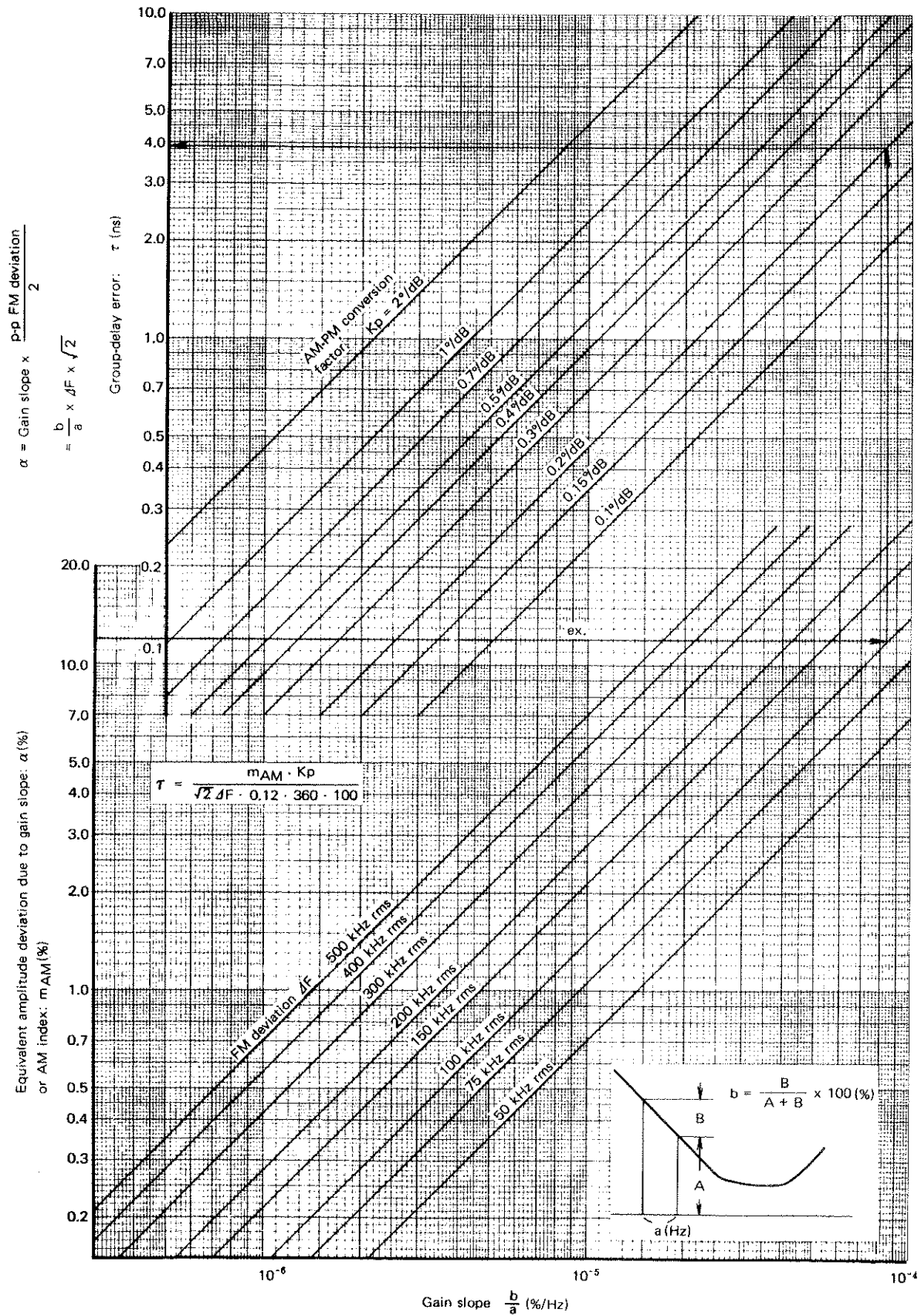

TABLE OF CONVERSION OF GROUP DELAY AND DIFFERENTIAL PHASE

